



Heat Shrinkable Moulded Shapes

Product Guide



**You are working on a higher level**  
We ensure highest quality



## **Perfect cable component solutions drawing on decades of engineering experience**

Decades of collaboration with customers in many industries qualify HellermannTyton as an ideal partner for standard and tailor-made part solutions around all aspects of cable management.

**New technologies place high demands on design and construction.**

We can contribute positively to acceleration of development and production processes whilst helping you to ensure highest quality standards and maintaining cost-effectiveness.

## Heat shrinkable moulded shapes expertise you can count on – worldwide

With HellermannTyton you have the right specialist at your side. Whether for cable bundling and fastening systems or for cable protection and identification solutions, our components are certified according to the current standards.

**In order to constantly reach and maintain this high level, we place great emphasis on keeping up a continuous interaction with our customers.** We have been working closely with the aerospace industry in this way for over 40 years. The result: products that are tailored exactly to the construction requirements and new innovations for your individual demands.

### Professional service worldwide.

Our network of branch offices and distribution partners around the globe ensures a consistently high level of service, high flexibility and the fast response and delivery times you expect.

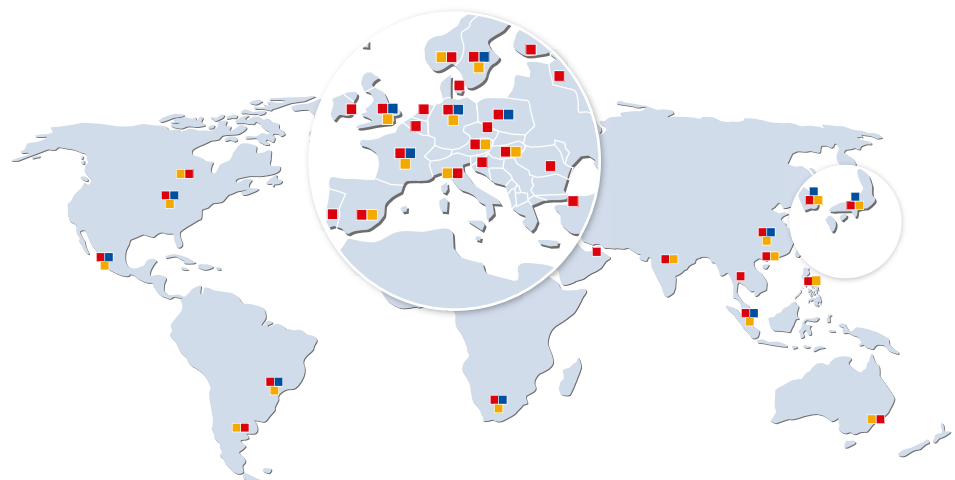

■ Sales Office   ■ Manufacturing & Research   ■ Distribution Centre



**You expect tailormade products**  
We offer you best-fit solutions

## Heat shrinkable moulded shapes solutions that meet your special demands

HellermannTyton heat shrinkable moulded shapes combine the advantages of quick, easy installation with high electric strength, mechanical toughness and superior chemical and environmental resistance. Our products offer important functional and cost saving benefits for electrical and electronic applications ranging from insulation and protection of individual components to fabrication of complete inter-connecting cable harness assemblies.

Strain-relieving boots, transitions and connector backshell covers, as well as other specialised shapes, are **available in a wide range of sizes and options**. HellermannTyton's extensive product line includes low profile, bulbous and lipped types for use on circular and D-type connectors as well as complex multiway transitions. Only a minimum number of shapes are needed to cover a full range.



## Your One-Stop-Cable-Management-Source: HellermannTyton

### Applications

The use of our heat shrinkable moulded shapes in conjunction with our specialist heat shrinkable tubings makes it easy to ensure the proper degree of mechanical support, strain relief and environmental protection. Encapsulating the complete harnessing and interconnection system to the desired configuration is easily and neatly accomplished, with minimum weight and bulk.

### Choice of Materials

A range of specially formulated materials is available to meet a variety of performance requirements.



*Low Profile Convolute Boots.*



*TSA-200 adhesive tape.*



*Right Angle Cross Shapes.*

**You need the perfect solution**  
We deliver thousands of them





Technical introduction  
**Page 8**



Heat Shrinkable Moulded Shapes  
**Page 20**



Cable Management Products  
**Page 76**



Appendix  
**Page 87**







## Technical Introduction

Selection Guide	10
Selection Guide Overview	12
Material Specifications	14
Adhesive Specifications	15
Material & Adhesive Combinations Research	16

This selection guide will help you to find the correct moulded shape for your application:

### Step 1. Product Style

Use the Selection Guide Overview on page 12 to quickly select a suitable product profile.

### Step 2. Product Size

Choose the correct dimensions to meet your application from our sizes and types table which appears on the relevant product profile page.

An example of these tables is shown below:

TYPE	ØH min. a	ØH max. b	ØJ min. a	ØJ max. b	P ± 10%	R ± 15%	T ± 0.8	JO ± 10%	HW ± 1.5	JW ± 0.8	S ± 1.5
313F322	23.8 (.93")	9.9 (.39")	17.2 (.67")	6.6 (.26")	105.9 (4.13")	11.6 (.45")	1.3 (.05")	86.3 (3.37")	1.5 (.06")	1.5 (.06")	1.5 (.06")
313F332	27.1 (1.06")	13.2 (.51")	20.8 (.81")	7.6 (.30")	121.1 (4.72")	12.1 (.47")	1.3 (.05")	98.5 (3.84")	1.5 (.06")	1.5 (.06")	1.5 (.06")

### Step 3. Material/ Adhesive

Choose a material and adhesive to meet your application requirements from the tables on page 14/15.

Further combinations are available.

Here is an example:

Combinations "On request"			
Adhesive	Material		
	9	8	6
TSA-200	•	•	•
-450	•	-	•
-250	•	-	•
W24	•	-	•
V9500	•	•	•
HMT200A	•	•	•
Without Adhesive	•	•	•

These symbols denote the material or adhesive availability for each profile type. In this example the adhesive W24 is not available with the material 8 because of the "-".

But it is available with the material 9 and 6 because of the "•".

### 3.1 Material

Parts can be supplied in a choice of materials. The "combinations" table on each product page provides a quick and easy material recognition guide for the product profiled.

On page 14 you will find detailed information on our range of materials.

### 3.2 Adhesive

To maximise environmental protection and strain relief we recommend the use of an adhesive from our range below.

**Pre-lined hot melt adhesive:**      **Component adhesive:**

- |   |  |
|---|--|
| <ul style="list-style-type: none"> <li>• WM250</li> <li>• W</li> <li>• W2</li> <li>• W8</li> <li>• W21</li> </ul> | <ul style="list-style-type: none"> <li>• HMT200A</li> <li>• W24</li> <li>• V9500</li> <li>• TSA-200</li> </ul> |
|---|--|

For further information on adhesives please refer to page 15.

#### Step 4. Standard combinations

Standard Combinations	
Type	Article Number
217-2-B7	402-17014
218-2-B7	402-18020
219-2-B7W	402-19039
220-1-B7	402-20008
216-3-B7	402-16057

To help you with your decision we offer standard combinations for each product type.

In this example we offer the Type 219-2 in B7 material and with the adhesive W.

### 5. Special Modifications

Filler ports and drain holes are also available where the injection of potting epoxy is required.

P = Filler ports for potting – 3mm Ø vent and 4.5mm Ø filler.

D = Drain holes for offset – 3mm Ø at H end equally spaced 90° apart.

### 6. Ordering Procedure

When ordering heat shrinkable shapes, it is necessary to give a complete part number to enable efficient processing of your order. Part numbers can be made up of the following typical components:

#### Example:

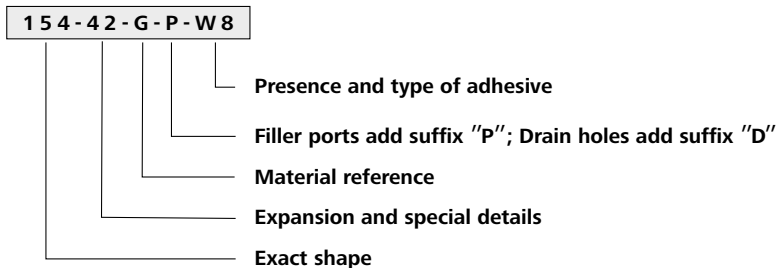



### Low Profile Boots and Transitions

Page

#### Convolute Boots

Helashrink 313C Series, with adapter lip

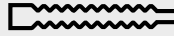

22

#### Shim Boots

Helashrink 313E Series, without adapter lip



23

#### Straight Boots

Helashrink 313F Series, with adapter lip

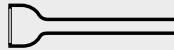

24

#### Right Angle Boots

Helashrink 333F Series, with adapter lip, 90° angle



25

### Low Profile Boots and Transitions

Page

#### Transition Boots

Helashrink 412H Series, side breakout

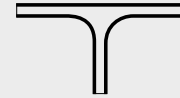

26

#### Transition Boots

Helashrink 492H Series, 1 to 2 cables



27

#### Transition Boots

Helashrink 573H Series, 1 to 3 cables

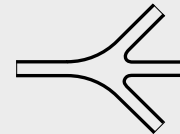

28

### Bulbous Boots and Transitions

Page

#### Bottle Shapes

Helashrink 150 Series, with rib, VG



29

#### Bottle Shapes

Helashrink 100 Series, with rib, MIL



31

#### Bottle Shapes

Helashrink 100 Series



33

#### Bottle Shapes

Helashrink 120 Series, without rib

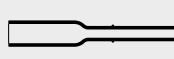

35

#### Bottle Shapes

Helashrink 120 Series, with rib

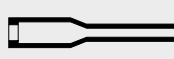

35

#### Long Outlet Shape

Helashrink 130 Series, with rib, low profile, VG

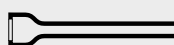

36

#### Long Outlet Shapes

Helashrink 140 Series, without rib

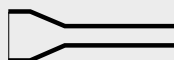

38

### Bulbous Boots and Transitions

Page

#### Bottle Shapes

Helashrink 160 Series, without rib

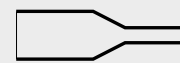

39

#### Bottle Shapes

Helashrink 170 Series, with rib, VG

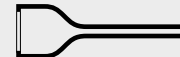

40

#### Bottle Shapes

Helashrink 190 Series, with external ribs, VG



41

#### 2-Way Outlet Shapes

Helashrink 200 Series, low profile



42

#### 2-Way Outlet Shapes

Helashrink 200 Series, VG



43

#### 2-Way Outlet Shapes

Helashrink 200 Series, in line, low voltage









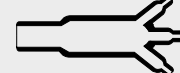



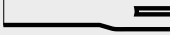



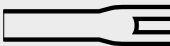
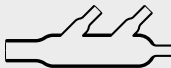

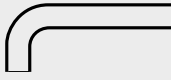

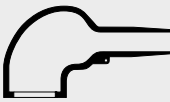
44, 78

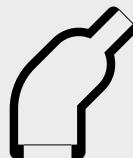
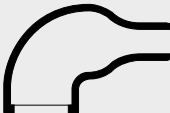
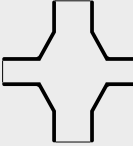
#### 3-Way Outlet Shapes

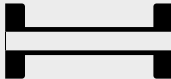
Helashrink 300 Series, VG

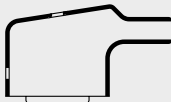
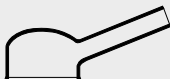

45

<p><b>3-Way Outlet Shapes</b> Helashrink 300 Series, in line, low voltage</p>  <p><b>46, 79</b></p>	<p><b>T-Shapes</b> Helashrink 1200 Series, Offset, VG</p>  <p><b>62</b></p>
<p><b>4-Way Outlet Shapes</b> Helashrink 400 Series, VG</p>  <p><b>47</b></p>	<p><b>Angled T-Shapes</b> Helashrink 1300 Series, 30° &amp; 45° angle, VG</p>  <p><b>63</b></p>
<p><b>4-Way Outlet Shapes</b> Helashrink 400 Series, in line, low voltage</p>  <p><b>48, 80</b></p>	<p><b>Double T-Shapes</b> Helashrink 1310 Series, 45° angle</p>  <p><b>64</b></p>
<p><b>5-Way Outlet Shapes</b> Helashrink 500 Series, in line, low voltage</p>  <p><b>49</b></p>	<p><b>Angle Elbow Shapes</b> Helashrink 1400 Series, 90° angle</p>  <p><b>65</b></p>
<p><b>6-Way Outlet Shapes</b> Helashrink 600 Series, in line, low voltage</p>  <p><b>50</b></p>	<p><b>Connector Cover for Min-D Series</b> Helashrink 1500 Series, with top entry</p>  <p><b>66</b></p>
<p><b>Right-Angle Shapes</b> Helashrink 1100 Series, with rib, VG</p>  <p><b>51</b></p>	<p><b>GSR Graduated Strain Relief</b> Helashrink 1750 Series, with rib</p>  <p><b>68</b></p>
<p><b>Right-Angle Shapes, VG style</b> Helashrink 1100 Series, without rib, thick wall</p>  <p><b>52</b></p>	<p><b>Angle Shapes</b> Helashrink 1800 Series, with rib, 30°, 45°, 60° angle</p>  <p><b>70</b></p>
<p><b>Right-Angle Shapes</b> Helashrink 1100 Series, with rib, MIL</p>  <p><b>53</b></p>	<p><b>Right Angle Cross Shapes</b> Helashrink 2000 Series - T-Joint</p>  <p><b>72</b></p>
<p><b>Right-Angle Shapes</b> Helashrink 1100 Series, without rib</p>  <p><b>55</b></p>	<p><b>Locating Bushes</b> Helashrink 1760, 1790, 1820 Series</p>  <p><b>73</b></p>
<p><b>Right-Angle Shapes</b> Helashrink 1100 Series, with rib, low profile, VG style/MIL style</p>  <p><b>57</b></p>	<p><b>Connector Cover for Min-D Series</b> Helashrink 2100 Series, with 90° entry</p>  <p><b>74</b></p>
<p><b>Right-Angle Shapes</b> Helashrink 1100 Series, with rib, low profile, high ratio, VG</p>  <p><b>59</b></p>	<p><b>Low voltage</b> Helashrink 1600 Series</p>  <p><b>81</b></p>
<p><b>T-Shapes</b> Helashrink 1200 Series, VG</p>  <p><b>60</b></p>	<p><b>Low voltage</b> Helashrink PEC Series, pinched</p>  <p><b>82</b></p>
<p><b>T-Shapes</b> Helashrink 1200 Series, Offset</p>  <p><b>61</b></p>	

## Materials for Heat Shrinkable Moulded Shapes

Material Specifications				
	L	H	G	B7
<b>Material</b>	Flexible flame retarded fluoroelastomer	Flexible limited fire hazard material	Fluid resistant elastomer	Semi-rigid flame retarded polyolefin
<b>Operating Temperature</b>	-67°F to +392°F (-55°C to +200°C)	-67°F to +221°F (-55°C to +105°C)	-103°F to +302°F (-75°C to +150°C)	-67°F to +275°F (-55°C to +135°C)
<b>Min. Shrink Temperature</b>	+347 °F (+175 °C)	+275 °F (+135 °C)	+275 °F (+135 °C)	+275 °F (+135 °C)
<b>Specifications</b>	DEF STAN 59-97, BSG198 Part 5, Type DD, MIL-81765/4	DEF STAN 59-97, BSG198 Part 5, Type DF, VG95343 pt 29, NAVSEA 5617649	DEF STAN 59-97, BSG198 Part 5, Type DE, VG 95343 Part 6, 18	MIL-I-81765/1 Type 1, DEF STAN 59-97, BSG198 Part 5, Type DA
<b>Tensile Strength</b>	12 MPa	10 MPa	15 MPa	13 MPa
<b>Elongation at break</b>	300 %	450 %	580 %	500 %
<b>Dielectric Strength</b>	8 kV/mm	15 kV/mm	14 kV/mm	14 kV/mm
<b>Flammability for Material</b>	Excellent	Excellent	Excellent	Excellent
<b>Features</b>	High temperature excellent chemical resistance	Low smoke Halogen free	Excellent resistance to fuels	Good physical and chemical resistance
<b>Typical Application</b>	Military and high performance harnessing	Ships, submarines and railways	Military and general high performance harnessing	Military and general high performance harnessing

Material Specifications					
	J	B8	-8	-9	-6
<b>Material</b>	Flexible polyolefin	Semi-rigid flame retarded polyolefin	Modified fluoroelastomer	Modified elastomer blend	Flexible flame retarded polyolefin
<b>Operating Temperature</b>	-67°F to +275°F (-55°C to +135°C)	-67°F to +212°F (-55°C to +100°C)	-67°F to +302°F (-55°C to +150°C)	-67°F to +248°F (-55°C to +120°C)	-67°F to +248°F (-55°C to +120°C)
<b>Min. Shrink Temperature</b>	+275 °F (+135 °C)	+275 °F (+135 °C)	+275 °F (+135 °C)	+275 °F (+135 °C)	+275 °F (+135 °C)
<b>Specifications</b>	MIL-I-81765/1 Type 2, DEF STAN 59-97, BSG198 Part 5, Type DB	EA-TS 09-11	SCX15111	SCX15112	MIL-I-81765/1 Type 1, MIL-I-81765/1 Type 2
<b>Tensile Strength</b>	14 MPa	15 MPa	15 MPa	12 MPa	12 MPa
<b>Elongation at break</b>	610 %	500 %	450 %	500 %	500 %
<b>Dielectric Strength</b>	12 kV/mm	15 kV/mm	20 kV/mm	20 kV/mm	20 kV/mm
<b>Flammability for Material</b>	excellent	good	<25mm	excellent	excellent
<b>Features</b>	Flexible	Good physical and reasonable chemical resistance	Good physical and reasonable chemical resistance	Good physical and reasonable chemical resistance	Good physical and reasonable chemical resistance
<b>Typical Application</b>	Military and high performance harnessing	Power/utility shapes	Military and general high performance harnessing	Military and general high performance harnessing	Military and general high performance harnessing

### Adhesive for Heat Shrinkable Moulded Shapes

Adhesive Specifications				
	W / W2	W8	W21	W24
<b>Adhesive</b>	General purpose hot melt adhesive	High performance EVA hot melt adhesive	Modified polyamide hot melt adhesive	High performance, pre-coat, 1 part epoxy
<b>Operating Temperature</b>	-67°F to +176°F (-55°C to +80°C)	-67°F to +221°F (-55°C to +105°C)	-67°F to +248°F (-55°C to +120°C)	-94°F to +428°F (-75°C to +200°C)
<b>Softening Point Adhesive</b>	+203°F (+95°C)	+230°F (+110°C)	+248°F (+120°C)	
<b>Supplied Form</b>	Pre-applied	Pre-applied	Pre-applied	Pre-applied
<b>Shelf life</b>	5 years	5 years	5 years	5 years
<b>Solvent Resistance</b>	Fair under splash conditions	Fair under splash conditions	Saline: Very good De-icing fluid: Good Diesel: Excellent Lubricating Oil: Good Hydraulic Oil: Excellent Aviation Fuel: Good Automotive Fuel: Good	De-icing fluid: Excellent Petrol: Excellent Lubricating Oil: Excellent Hydraulic Oil: Excellent

Adhesive Specifications					
	450	TSA200	WM250	V9500	HMT200A
<b>Adhesive</b>	EVA hot melt adhesive	Thermoset +125° C	Hot melt adhesive	Two part, black, epoxy adhesive	Hot melt adhesive tape
<b>Operating Temperature</b>	-67°F to +221°F (-55°C to +105°C)	-67°F to +257°F (-55°C to +125°C)	-67°F to +176°F (-55°C to +80°C)	-103°F to +302°F (-75°C to +150°C)	-67°F to +221°F (-55°C to +105°C)
<b>Softening Point Adhesive</b>	+230°F (+110°C)	+203°F (+95°C)	+203°F (+95°C)		+230°F (+110°C)
<b>Supplied Form</b>	Pre-applied	Tape	Pre-applied	Cardridge	Tape
<b>Shelf life</b>	5 years	5 years	5 years	18 months	5 years
<b>Solvent Resistance</b>	Fair under splash conditions	Fair under splash conditions	Fair under splash conditions	De-icing fluid: Excellent, Petrol: Excellent, Lubricating Oil: Excellent, Hydraulic Oil: Excellent	Fair under splash conditions

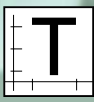

Use this table to find the adhesive compatibility for your preferred material.

Material Combinations	Material			
	G	B7	B8	H
<b>Material Description</b>	Fluid resistant elastomer	Semi -rigid flame retarded polyolefin	Semi -rigid flame retarded polyolefin	Flexible limited fire hazard polyolefin
<b>Shape</b>				
<b>Minimum Shrink Temperature</b>	+275°F (+135°C)	+275°F (+135°C)	+275°F (+135°C)	+275°F (+135°C)
<b>Operating Temperature Range</b>	-103°F to +302°F (-75°C to +150°C)	-67°F to +275°F (-55°C to +135°C)	-67°F to +212°F (-55°C to +100°C)	-67°F to +221°F (-55°C to +105°C)
<b>Shelf Life</b>	5 years	5 years	5 years	5 years
<b>Helashrink 100 Series</b>	yes	yes	no	yes
<b>Helashrink 1100 Series</b>	yes	yes	no	yes
<b>Helashrink 200 Series</b>	yes	yes	no	yes
<b>Helashrink 300 Series</b>	yes	yes	no	yes
<b>Helashrink 400 Series</b>	yes	yes	no	yes
<b>Helashrink 1200 Series</b>	yes	yes	no	yes
<b>Helashrink 1300 Series</b>	yes	yes	no	yes
<b>Low Profile Shapes (Series 313, 412, 492, 573)</b>	no	no	no	no
<b>Helashrink 1600 Series</b>	no	no	yes	no
<b>Helashrink In Line Series, low voltage</b>	no	no	yes	no
<b>Adhesive Compatibility</b>	WM250	WM250	WM250	WM250
	W8	W8	W8	W8
	W24	W24		W24
	V9500	V9500		W21
	HMT200A	HMT200A	HMT200A	HMT200A



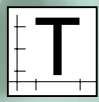

Material Combinations	Material			
	L	-9	-6	-8
<b>Material Description</b>	Flexible flame retarded fluoroelastomer	Modified elastomer blend	Flexible flame retarded polyolefin	Fluoro-elastomer polymer blend
<b>Shape</b>		low profile	low profile	low profile
<b>Minimum Shrink Temperature</b>	+347°F (+175°C)	+275°F (+135°C)	+275°F (+135°C)	+275°F (+135°C)
<b>Operating Temperature Range</b>	-67°F to +392°F (-55°C to +200°C)	-67°F to +248°F (-55°C to +120°C)	-67°F to +248°F (-55°C to +120°C)	-67°F to +302°F (-55°C to +150°C)
<b>Shelf Life</b>	5 years	5 years	5 years	5 years
<b>Helashrink 100 Series</b>	yes	no	no	no
<b>Helashrink 1100 Series</b>	yes	no	no	no
<b>Helashrink 200 Series</b>	yes	no	no	no
<b>Helashrink 300 Series</b>	yes	no	no	no
<b>Helashrink 400 Series</b>	yes	no	no	no
<b>Helashrink 1200 Series</b>	yes	no	no	no
<b>Helashrink 1300 Series</b>	yes	no	no	no
<b>Low Profile Shapes (Series 313, 412, 492, 573)</b>	no	yes	yes	yes
<b>Helashrink 1600 Series</b>	no	no	no	no
<b>Helashrink In Line Series, low voltage</b>	no	no	no	no
<b>Adhesive Compatibility</b>	W24 V9500	WM250 W8 W24 V9500 HMT200A TSA200	WM250 W8 W24 V9500 HMT200A TSA200	TSA200

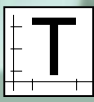

Use this table to find the material compatibility for your preferred adhesive.

Adhesive Combinations	Material			
	W / W2	WM250	W8	W21
<b>Adhesive Description</b>	General purpose hot melt adhesive	General purpose hot melt adhesive	EVA, high performance, hot melt adhesive	Modified polyamide hot melt adhesive
<b>Operating Temperature Range</b>	-67°F to +176°F (-55°C to +80°C)	-67°F to +176°F (-55°C to +80°C)	-67°F to +221°F (-55°C to +105°C)	-67°F to +248°F (-55°C to +120°C)
<b>Softening Point</b>	+203°F (+95°C)	+203°F (+95°C)	+230°F (+110°C)	-
<b>Supplied Form</b>	pre-applied	pre-applied	pre-applied	pre-applied
<b>Shelf Life</b>	5 years	5 years	5 years	5 years
<b>Solvent Resistance</b>	Fair under splash conditions	Fair under splash conditions	Fair under splash conditions	Saline: Very good De-icing fluid: Good Diesel: Excellent Lubricating Oil: Good Hydraulic Oil: Good Aviation Fuel: Good Automotive Fuel: Good
<b>Helashrink 100 Series</b>	no	yes	yes	yes
<b>Helashrink 1100 Series</b>	no	yes	yes	yes
<b>Helashrink 200 Series</b>	no	yes	yes	yes
<b>Helashrink 300 Series</b>	no	yes	yes	yes
<b>Helashrink 400 Series</b>	no	yes	yes	yes
<b>Helashrink 1200 Series</b>	no	yes	yes	yes
<b>Helashrink 1300 Series</b>	no	yes	yes	yes
<b>Low Profile Shapes (Series 313, 412, 492, 573)</b>	no	yes	yes	yes
<b>Helashrink 1600 Series</b>	yes	yes	no	no
<b>Helashrink In Line Series, low voltage</b>	yes	yes	no	no
<b>Material Compatibility</b>	B8	G	G	G
		B7	B7	B7
		B8	H	B8
		H	6	H
		6	9	
		9		



Adhesive Combinations	Material			
	W24	TSA-200	V9500	HMT200A
<b>Adhesive Description</b>	High performance, pre-coat, 1 part epoxy	Thermoset +125°C	Two part, black, epoxy adhesive	Hot melt adhesive tape
<b>Operating Temperature Range</b>	-103°F to +392°F (-75°C to +200°C)	-67°F to +257°F (-55°C to +125°C)	-103°F to +302°F (-75°C to +150°C)	-67°F to +221°F (-55°C to +105°C)
<b>Softening Point</b>	-	-	-	-
<b>Supplied Form</b>	pre-applied	Tape	Cartridge	Tape
<b>Shelf Life</b>	5 years	5 years	18 months	5 years
<b>Solvent Resistance</b>	De-icing fluid: Excellent Petrol: Excellent Lubricating Oil: Excellent Hydraulic Oil: Excellent	Fair under splash conditions	De-icing fluid: Excellent Petrol: Excellent Lubricating Oil: Excellent Hydraulic Oil: Excellent	Fair under splash conditions
<b>Helashrink 100 Series</b>	yes	no	yes	yes
<b>Helashrink 1100 Series</b>	yes	no	yes	yes
<b>Helashrink 200 Series</b>	yes	no	yes	yes
<b>Helashrink 300 Series</b>	yes	no	yes	yes
<b>Helashrink 400 Series</b>	yes	no	yes	yes
<b>Helashrink 1200 Series</b>	yes	no	yes	yes
<b>Helashrink 1300 Series</b>	yes	no	yes	yes
<b>Low Profile Shapes (Series 313, 412, 492, 573)</b>	yes	yes	yes	yes
<b>Helashrink 1600 Series</b>	no	no	no	yes
<b>Helashrink In Line Series, low voltage</b>	no	no	no	yes
<b>Material Compatibility</b>	G	6	G	G
	B7	9	B7	B7
	H	9	H	B8
	L		J	H
	6			6
	9			9
	J			8
				J



## 2.1 Low Profile Boots and Transitions

Convolute Boots	Helashrink 313C Series, with adapter lip	22
Shim Boots	Helashrink 313E Series, without adapter lip	23
Straight Boots	Helashrink 313F Series, with adapter lip	24
Right Angle Boots	Helashrink 333F Series, with adapter lip, 90° angle	25
	Helashrink 412H Series, side breakout	26
Transition Boots	Helashrink 492H Series, 1 to 2 cables	27
	Helashrink 573H Series, 1 to 3 cables	28



## 2.2 Bulbous Boots and Transitions

Bottle Shapes	Helashrink 150 Series, with rib, VG	29
	Helashrink 100 Series, with rib, MIL	31
	Helashrink 100 Series, without rib	33
	Helashrink 120 Series, without rib	35
Long Outlet Shape	Helashrink 120 Series, with rib	35
	Helashrink 130 Series, with rib, low profile, VG	36
Long Outlet Shapes	Helashrink 140 Series, without rib	38
	Helashrink 160 Series, without rib	39
Bottle Shapes	Helashrink 170 Series, with rib, VG	40
	Helashrink 190 Series, with external ribs, VG	41
	Helashrink 200 Series, low profile	42
	Helashrink 200 Series, VG	43
2-Way Outlet Shapes	Helashrink 200 Series, in line, low voltage	44
	Helashrink 300 Series, VG	45
3-Way Outlet Shapes	Helashrink 300 Series, in line, low voltage	46
	Helashrink 400 Series, VG	47
4-Way Outlet Shapes	Helashrink 400 Series, in line, low voltage	48
	Helashrink 500 Series, in line, low voltage	49
5-Way Outlet Shapes	Helashrink 500 Series, in line, low voltage	49
6-Way Outlet Shapes	Helashrink 600 Series, in line, low voltage	50



	Helashrink 1100 Series, with rib, VG	51
	Helashrink 1100 Series, without rib, thick wall, VG	52
Right-Angle Shapes	Helashrink 1100 Series, with rib, MIL	53
	Helashrink 1100 Series, without rib	55
	Helashrink 1100 Series, with rib, low profile, VG style/MIL style	57
	Helashrink 1100 Series, with rib, low profile, high ratio, VG	59
	Helashrink 1200 Series, VG/MIL	60
	Helashrink 1200 Series, Offset	61
T-Shapes	Helashrink 1200 Series, Offset, VG	62
	Helashrink 1300 Series, 30° & 45° angle, VG	63
Angled T-Shapes	Helashrink 1310 Series, 30° angle	64
Double T-Shapes	Helashrink 1400 Series, 90° angle	65
Angle Elbow Shapes	Helashrink 1500 Series, with top entry	66
Connector Cover for Min-D Series	Helashrink 1750 Series, with rib	68
GSR Graduated Strain Relief	Helashrink 1800 Series, with rib, 30°, 45°, 60° angle	70
Angle Shapes	Helashrink 2000 Series - T-Joint	72
Right Angle Cross Shapes	Helashrink 1760, 1790, 1820 Series	73
Locating Bushes	Helashrink 2100 Series, with 90° entry	74
Connector Cover for Min-D Series		



### Low Profile Convolute Boots

#### Helashrink 313C Series, with adapter lip

- For circular grooved adapters to provide strain relief
- Excellent environmental sealing with adhesive
- Convoluted design grants flexibility for different cable outlet angles



313C722-774 Series supplied / fully recovered.

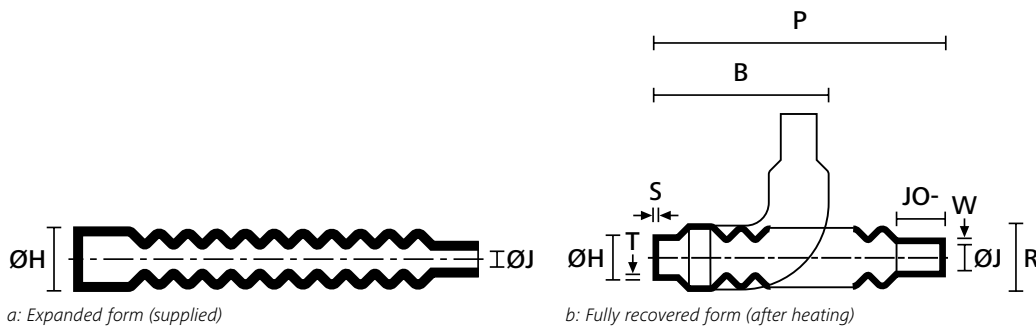

TYPE	ØH min. a	ØH max. b	ØJ min. a	ØJ max. b	P ± 10%	R max.	JO ± 10%	W min.	B nom.	T ± 0.5	S ± 0.5
313C722	14.2 (.55")	6.9 (.27")	11.1 (.43")	4.8 (.19")	120.6 (4.70")	21.1 (.82")	17.3 (.67")	1.5 (.06")	62.4 (2.43")	1.3 (.05")	1.5 (.06")
313C732	22.4 (.87")	11.7 (.46")	17.7 (.69")	8.1 (.32")	133.3 (5.20")	26.5 (1.03")	19.8 (.77")	1.5 (.06")	67.8 (2.64")	1.3 (.05")	1.5 (.06")
313C743	34.0 (1.33")	17.5 (.68")	26.9 (1.05")	12.7 (.50")	146.0 (5.69")	32.7 (1.28")	22.3 (.87")	1.5 (.06")	73.4 (2.86")	1.3 (.05")	1.8 (.07")
313C753	44.2 (1.72")	22.3 (.87")	36.5 (1.42")	17.5 (.68")	158.7 (6.19")	37.8 (1.47")	25.4 (1")	1.5 (.06")	78.2 (3.05")	1.3 (.05")	1.8 (.07")
313C764	53.8 (2.10")	40.6 (1.09")	45.7 (1.78")	22.3 (.87")	171.4 (6.68")	42.9 (1.67")	28.4 (1.11")	1.5 (.06")	82.8 (3.23")	2.0 (.08")	1.8 (.07")
313C774	77.2 (3.01")	40.6 (1.58")	54.6 (2.13")	22.8 (.89")	236.2 (9.21")	62.2 (2.43")	25.4 (1")	1.5 (.06")	138.4 (5.40")	2.0 (.08")	2.0 (.078")

Dimensions in mm, inches in brackets. Subject to technical changes.

Combinations "On request"			
Adhesive	Material		
	9	8	6
TSA-200	•	•	•
-450	•	-	•
-250	•	-	•
W24	•	-	•
V9500	•	-	•
HMT200A	•	-	•
Without Adhesive	•	•	•

Standard Combinations	
Type	Article Number
313C722-9	422-00001
313C732-9	422-00101
313C743-9	422-00201
313C753-9	422-00302
313C764-9	422-00400
313C774-9	422-00501

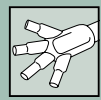

### Low Profile Shim Boots

#### Helashrink 313E Series, without adapter lip

- Used to build up or shim a cable diameter
- Facilitates better fit for components in cable harness



For Material / Adhesive selection and other information please refer to page 10.



313E445-457 Series supplied / fully recovered.



a: Expanded form (supplied)

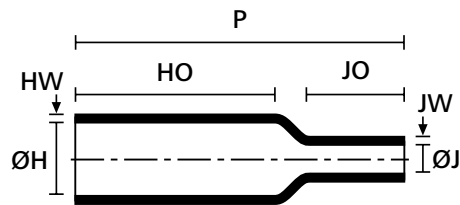

b: Fully recovered form (after heating)

TYPE	ØH min. a	ØH max. b	ØJ min. a	ØJ max. b	P ± 10%	HO ± 10%	HW ± 25%	JW ± 25%	JO ± 10%
313E445	12.7 (.50")	12.7 (.50")	11.1 (.43")	3.3 (.13")	63.5 (2.48")	41.1 (1.6")	1.5 (.06")	1.5 (.06")	15.7 (.61")
313E447	20.8 (.81")	14.7 (.57")	20.6 (.80")	9.9 (.39")	63.5 (2.48")	41.1 (1.6")	1.5 (.06")	1.5 (.06")	16.5 (.64")
313E455	22.1 (.86")	22.1 (.86")	11.2 (.44")	3.3 (.13")	53.3 (2.08")	27.9 (1.09")	2.3 (.089")	1.5 (.06")	15.7 (.61")
313E457	22.1 (.86")	22.1 (.86")	20.6 (.80")	9.9 (.39")	53.3 (2.08")	27.9 (1.09")	2.3 (.089")	1.5 (.06")	14.0 (.54")

Dimensions in mm, inches in brackets. Subject to technical changes.

Combinations "On request"			
Adhesive	Material		
	9	8	6
TSA-200	•	•	•
-450	•	-	•
-250	•	-	•
W24	•	-	•
V9500	•	-	•
HMT200A	•	-	•
Without Adhesive	•	•	•

Standard Combinations	
Type	Article Number
313E445-9	422-10000
313E447-9	422-10100
313E455-9	422-10200
313E457-9	422-10300



### Low Profile Straight Boots

#### Helashrink 313F Series, with adapter lip

- Connector strain relief for small cable diameters requiring high shrink ratio



**For Material / Adhesive selection and other information please refer to page 10.**



313F322-396 Series supplied / fully recovered.

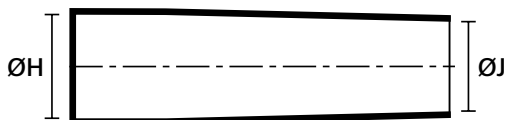

a: Expanded form (supplied)

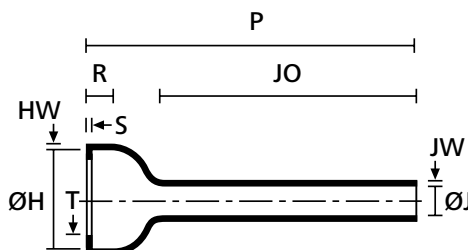

b: Fully recovered form (after heating)

TYPE	ØH min. a	ØH max. b	ØJ min. a	ØJ max. b	P ± 10%	R ± 15%	T ± 0.8	JO ± 10%	HW ± 1.5	JW ± 0.8	S ± 1.5
313F322	23.8 (.93")	9.9 (.39")	17.2 (.67")	6.6 (.26")	105.9 (4.13")	11.6 (.45")	1.3 (.05")	86.3 (3.37")	1.5 (.06")	1.5 (.06")	1.5 (.06")
313F332	27.1 (1.06")	13.2 (.51")	20.8 (.81")	7.6 (.30")	121.1 (4.72")	12.1 (.47")	1.3 (.05")	98.5 (3.84")	1.5 (.06")	1.5 (.06")	1.5 (.06")
313F343	30.9 (1.21")	18.5 (.72")	24.3 (.95")	8.9 (.35")	138.6 (5.41")	12.1 (.47")	1.3 (.05")	112.7 (4.4")	1.7 (.066")	1.5 (.06")	1.7 (.066")
313F353	35.6 (1.39")	22.1 (.86")	28.7 (1.12")	10.1 (.39")	159.5 (6.22")	12.1 (.47")	1.3 (.05")	13.8 (5.1")	1.7 (.066")	1.5 (.06")	1.7 (.066")
313F364	38.8 (1.51")	28.2 (1.10")	31.4 (1.22")	10.9 (.43")	177.8 (6.93")	13.9 (.54")	1.8 (.07")	142.2 (5.54")	1.7 (.066")	1.5 (.06")	1.7 (.066")
313F374	42.2 (1.65")	32.2 (1.26")	38.3 (1.49")	12.7 (.50")	203.2 (7.92")	15.2 (.59")	1.8 (.07")	163.0 (6.36")	1.7 (.066")	1.5 (.06")	1.7 (.066")
313F385	51.5 (2.01")	45.4 (1.77")	45.4 (1.77")	14.9 (.58")	203.2 (7.92")	15.2 (.59")	1.8 (.07")	157.7 (6.15")	1.7 (.066")	1.7 (.066")	1.7 (.066")
313F396	62.7 (2.45")	45.4 (1.77")	53.3 (2.08")	16.7 (.65")	228.6 (8.92")	16.0 (.62")	1.8 (.07")	153.1 (5.97")	1.7 (.066")	1.7 (.066")	1.7 (.066")

Dimensions in mm, inches in brackets. Subject to technical changes.

Combinations "On request"			
Adhesive	Material		
	9	8	6
TSA-200	•	•	•
-450	•	-	•
-250	•	-	•
W24	•	-	•
V9500	•	-	•
HMT200A	•	-	•
Without Adhesive	•	•	•

Standard Combinations	
Type	Article Number
313F322-9	422-20000
313F332-9	422-20100
313F343-9	422-20200
313F353-9	422-20300
313F364-9	422-20400
313F374-9	422-20500
313F385-9	422-20600
313F396-9	422-20700





### Low Profile Right Angle Boots

#### Helashrink 333F Series, with adapter lip, 90° angle

- Connector strain relief for small cable diameters requiring high shrink ratio

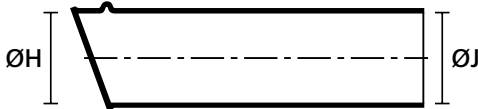

a: Expanded form (supplied)

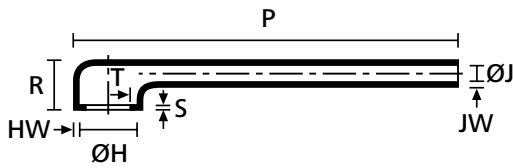

b: Fully recovered form (after heating)



333F322-385 Series supplied / fully recovered.

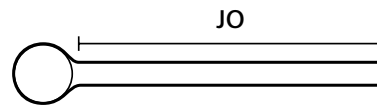

Fully recovered form (after heating)

TYPE	ØH min. a	ØH max. b	ØJ min. a	ØJ max. b	P ± 10%	R ± 15%	T ± 0.8	HW ± 1.5	JW ± 0.8	S ± 1.5
333F322	23.8 (.93")	9.9 (.39")	17.2 (.67")	6.6 (.26")	105.1 (4.10")	18.5 (.72")	1.3 (.05")	1.5 (.06")	1.5 (.06")	1.5 (.06")
333F332	27.1 (1.06")	13.2 (.51")	20.8 (.81")	7.6 (.30")	115.8 (4.52")	19.8 (.77")	1.3 (.05")	1.5 (.06")	1.5 (.06")	1.5 (.06")
333F343	30.9 (1.21")	18.5 (.72")	24.3 (.95")	8.9 (.35")	146.3 (5.71")	20.8 (.81")	1.3 (.05")	1.7 (.066")	1.5 (.06")	1.7 (.066")
333F353	35.3 (1.38")	21.6 (.84")	28.7 (1.12")	10.1 (.39")	172.2 (6.72")	21.8 (.85")	1.3 (.05")	1.7 (.066")	1.5 (.06")	1.7 (.066")
333F364	38.8 (1.51")	27.9 (1.09")	31.4 (1.22")	10.9 (.43")	185.1 (7.22")	24.1 (.94")	1.8 (.07")	1.7 (.066")	1.5 (.06")	1.7 (.066")
333F374	45.2 (1.76")	34.0 (1.33")	38.3 (1.49")	12.1 (.47")	213.6 (8.33")	27.4 (1.06")	1.8 (.07")	1.7 (.066")	1.5 (.06")	1.7 (.066")
333F385	51.5 (2.01")	41.1 (1.60")	44.4 (1.73")	15.0 (.59")	224.5 (8.76")	29.4 (1.15")	1.7 (.045")	1.7 (.066")	1.7 (.066")	1.7 (.066")

Dimensions in mm, inches in brackets. Subject to technical changes.

Combinations "On request"			
Adhesive	Material		
	9	8	6
TSA-200	•	•	•
-450	•	-	•
-250	•	-	•
W24	•	-	•
V9500	•	-	•
HMT200A	•	-	•
Without Adhesive	•	•	•

Standard Combinations	
Type	Article Number
333F322-9	422-30000
333F332-9	422-30004
333F343-9	422-30100
333F353-9	422-30200
333F364-9	422-30301
333F374-9	422-30400
333F385-9	422-30500



### Low Profile Transition Boots

#### Helashrink 412H Series, side breakout

- Connector cable strain relief
- Used with circular adaptors



412H622-625 Series supplied / fully recovered.

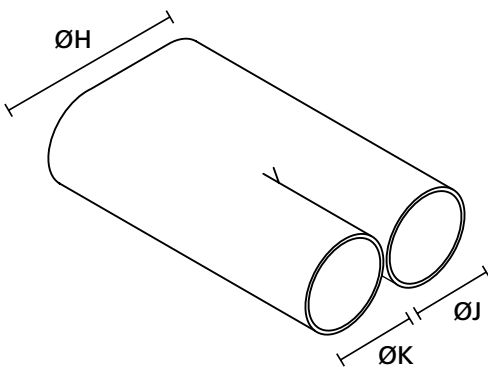

a: Expanded form (supplied)

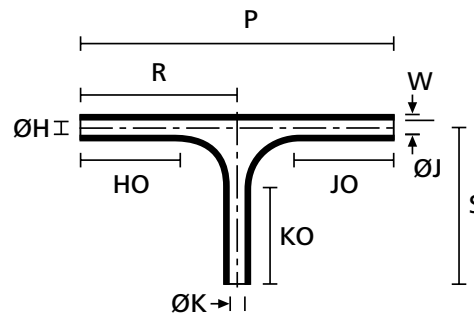

b: Fully recovered form (after heating)

TYPE	ØH min. a	ØH max. b	ØJ/K min. a	ØJ/K max. b	HO/JO/KO ± 10%	P nom.	W nom.	R/S nom.
412H622	19.8 (.77")	6.6 (.26")	13.2 (.51")	6.6 (.25")	25.4 (1")	80.7 (3.15")	1.0 (.039")	40.3 (1.57")
412H623	34.2 (1.33")	11.4 (.44")	22.8 (.88")	6.6 (.25")	41.1 (1.6")	12.3 (4.69")	1.3 (.05")	60.1 (2.34")
412H624	60.1 (2.34")	20.0 (.78")	40.1 (1.56")	20 (.78")	63.5 (2.47")	175.7 (6.85")	1.5 (.06")	87.8 (3.42")
412H625	83.3 (3.25")	33.2 (1.29")	54.8 (2.13")	33.2 (1.29")	88.9 (3.46")	242.3 (9.45")	1.7 (.066")	121.1 (4.72")

Dimensions in mm, inches in brackets. Subject to technical changes.

Combinations "On request"			
Adhesive	Material		
	9	8	6
TSA-200	•	•	•
-450	•	-	•
-250	•	-	•
W24	•	-	•
V9500	•	-	•
HMT200A	•	-	•
-200	•	-	•
Without Adhesive	•	•	•

Standard Combinations	
Type	Article Number
412H622-9	422-40000
412H623-9	422-40100
412H624-9	422-40200
412H625-9	422-40300

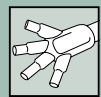

### Low Profile Transition Boots

#### Helashrink 492H Series, 1 to 2 cables

- For cable harness breakouts or transitions
- Strain relief, sealing and mechanical protection



For Material / Adhesive selection and other information please refer to page 10.



492H412-415 Series supplied / fully recovered.

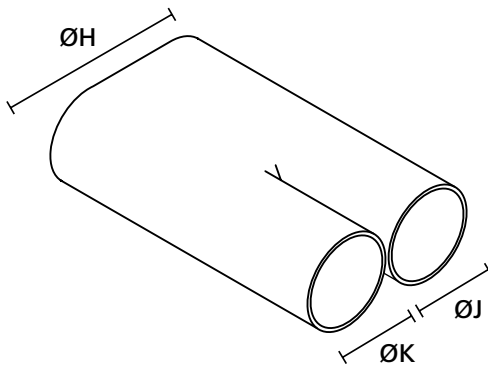

a: Expanded form (supplied)

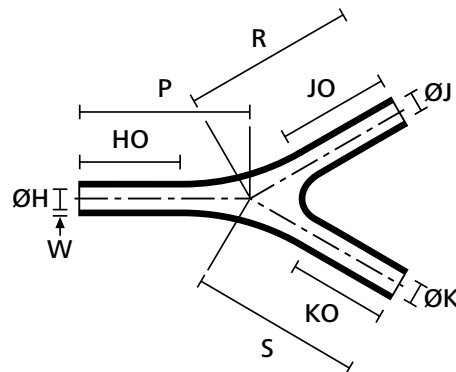

b: Fully recovered form (after heating)

TYPE	ØH min. a	ØH max. b	ØJ/K min. a	ØJ/K max. b	HO/JO/KO ± 15%	W nom.	P/R/S nom.
492H412	19.8 (.77")	6.6 (.26")	13.2 (.51")	6.6 (.25")	25.4 (1")	1.0 (.039")	40.6 (1.58")
492H413	34.2 (1.33")	11.4 (.44")	22.8 (.88")	11.4 (.44")	41.1 (1.6")	1.3 (.05")	62.9 (2.45")
492H414	60.1 (2.34")	20.0 (.78")	40.1 (1.56")	20.0 (.78")	63.5 (2.48")	1.5 (0.06")	94.7 (3.69")
492H415	83.3 (3.25")	33.2 (1.29")	54.8 (2.14")	33.2 (1.29")	49.7 (1.94")	1.7 (.066")	133.8 (5.22")

Dimensions in mm, inches in brackets. Subject to technical changes.

Combinations "On request"			
Adhesive	Material		
	9	8	6
TSA-200	•	•	•
-450	•	-	•
-250	•	-	•
W24	•	-	•
V9500	•	-	•
HMT200A	•	-	•
-200	•	-	•
Without Adhesive	•	•	•

Standard Combinations	
Type	Article Number
492H412-9	422-50000
492H413-9	422-50101
492H414-9	422-50202
492H415-9	422-50302



#### Low Profile Transition Boots

##### Helashrink 573H Series, 1 to 3 cables

- For cable harness breakouts or transitions
- Strain relief, sealing and mechanical protection



573H532-535 Series supplied / fully recovered.

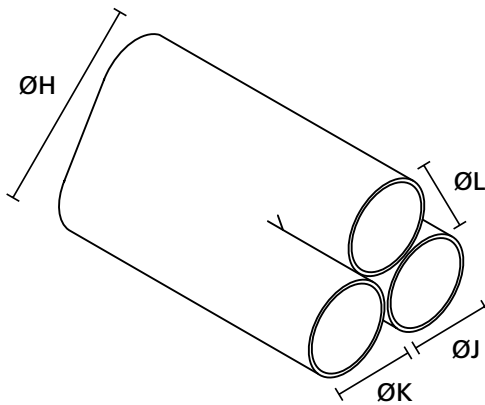

a: Expanded form (supplied)

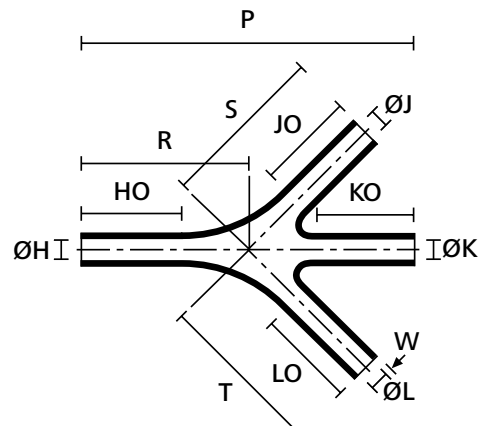

b: Fully recovered form (after heating)

TYPE	ØH min. a	ØH max. b	ØJ/K/L min. a	ØJ/K/L max. b	P nom.	R/S/T nom.	W nom.	HO/JO /KO/LO ± 15%
573H532	19.8 (.77")	6.6 (.26")	13.2 (.51")	6.6 (.26")	85.8 (3.35")	42.9 (1.67")	1.0 (.039")	25.4 (1")
573H533	34.2 (1.33")	11.4 (.44")	20.5 (.80")	11.4 (.44")	135.6 (5.29")	67.8 (2.64")	1.3 (.05")	41.1 (1.6")
573H534	60.1 (2.34")	20.0 (.78")	36.0 (1.40")	20.0 (.78")	207.2 (8.08")	103.6 (4.04")	1.5 (.06")	63.5 (2.47")
573H535	99.8 (3.89")	33.2 (1.29")	54.8 (2.13")	33.2 (1.29")	294.6 (11.49")	147.3 (5.74")	1.7 (.066")	88.9 (3.46")

Dimensions in mm, inches in brackets. Subject to technical changes.

Combinations "On request"			
Adhesive	Material		
	9	8	6
TSA-200	•	•	•
-450	•	-	•
-250	•	-	•
V9500	•	-	•
HMT200A	•	-	•
-200	•	-	•
Without Adhesive	•	•	•

Standard Combinations	
Type	Article Number
573H532-9	422-60000
573H533-9	422-60100
573H534-9	422-60202
573H535-9	422-60302



### Bottle Shapes, VG style

#### Helashrink 150 Series, with rib

- Use in conjunction with circular grooved adaptors
- For strain relief and environmental sealing



150 Series boot recovered onto a connectors.



**For Material / Adhesive selection and other information please refer to page 10.**



150 Series supplied.

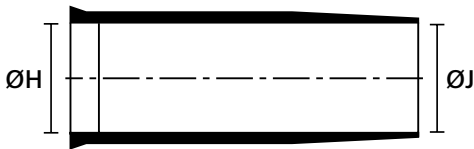

a: Expanded form (supplied)

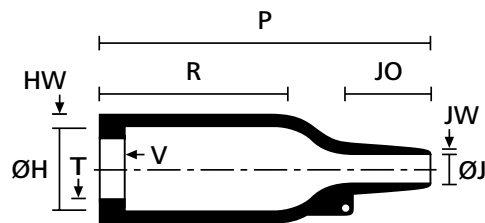

b: Fully recovered form (after heating)

TYPE	Designation as per AS/VG-Norm	ØH min. a	ØH max. b	ØJ min. a	ØJ max. b	P ± 10%	R ± 10%	JO ± 10%	HW ± 20%	JW ± 20%	V ± 10%	T ± 20%
152-41	VG 95343 T06 A 001 A	24.0 (.94")	10.5 (.41")	24.0 (.94")	6.0 (.23")	26.0 (1.01")	9.0 (.35")	10.0 (.39")	1.6 (.06")	0.5 (.02")	3.0 (.12")	1.0 (.04")
152-42	VG 95343 T06 B 001 A	24.0 (.94")	10.5 (.41")	24.0 (.94")	6.0 (.23")	38.0 (1.48")	21.0 (.82")	10.0 (.39")	1.6 (.06")	0.5 (.02")	3.0 (.12")	1.0 (.04")
153-41	VG 95343 T06 A 002 A	25.0 (.98")	14.0 (.55")	9.0 (.35")	3.5 (.14")	40.0 (1.56")	13.0 (.51")	16.0 (.62")	1.8 (.07")	0.5 (.02")	3.0 (.12")	1.0 (.04")
153-42	VG 95343 T06 B 002 A	25.0 (.98")	14.0 (.55")	9.0 (.35")	3.5 (.14")	55.0 (2.15")	28.0 (1.09")	16.0 (.62")	1.8 (.07")	0.5 (.02")	3.0 (.12")	1.0 (.04")
154-41	VG 95343 T06 A 003 A	30.0 (1.17")	14.0 (.55")	30.0 (1.17")	6.0 (.23")	43.0 (1.68")	20.0 (.78")	13.0 (.51")	1.8 (.07")	1.0 (.04")	3.0 (.12")	1.0 (.04")
154-42	VG 95343 T06 B 003 A	30.0 (1.17")	14.0 (.55")	30.0 (1.17")	6.0 (.23")	55.0 (2.15")	32.0 (1.25")	13.0 (.51")	1.8 (.07")	1.0 (.04")	3.0 (.12")	1.0 (.04")
155-41	VG 95343 T06 A 004 A	31.0 (1.21")	18.0 (.7")	31.0 (1.21")	7.0 (.27")	47.0 (1.83")	15.0 (.59")	18.0 (.70")	1.8 (.07")	1.0 (.04")	3.0 (.12")	1.0 (.04")

Dimensions in mm, inches in brackets. Subject to technical changes.



## Bottle Shapes, VG style

Helashrink 150 Series, with rib

TYPE	Designation as per AS/VG-Norm	ØH min. a	ØH max. b	ØJ min. a	ØJ max. b	P ± 10%	R ± 10%	JO ± 10%	HW ± 20%	JW ± 20%	V ± 10%	T ± 20%
155-42	VG 95343 T06 B 004 A	31.0 (1.21")	18.0 (.7")	31.0 (1.21")	7.0 (.27")	67.0 (2.61")	35.0 (1.37")	18.0 (.7")	1.8 (.07")	1.0 (.04")	3.0 (.12")	1.0 (.04")
156-41	VG 95343 T06 A 005 A	36.0 (1.4")	22.5 (.88")	36.0 (1.4")	8.5 (.33")	60.0 (2.34")	22.0 (.86")	20.0 (.78")	2.0 (.08")	1.0 (.04")	3.0 (.12")	1.0 (.04")
156-42	VG 95343 T06 B 005 A	36.0 (1.4")	22.5 (.88")	36.0 (1.4")	8.5 (.33")	80.0 (3.12")	42.0 (1.64")	20.0 (.78")	2.0 (.08")	1.0 (.04")	3.0 (.12")	1.0 (.04")
157-42	VG 95343 T06 B 006 A	43.0 (1.68")	28.0 (1.09")	43.0 (1.68")	10.0 (.39")	79.0 (3.08")	41.0 (1.6")	20.0 (.78")	2.2 (.09")	1.0 (.04")	3.0 (.12")	1.7 (.07")
157-43	VG 95343 T06 C 001 A	43.0 (1.68")	28.0 (1.09")	43.0 (1.68")	10.0 (.39")	99.0 (3.86")	61.0 (2.38")	20.0 (.78")	2.2 (.09")	1.0 (.04")	3.0 (.12")	1.7 (.07")
158-41	VG 95343 T06 A 007 A	60.0 (2.34")	35.0 (1.37")	60.0 (2.34")	16.0 (.62")	90.0 (3.51")	32.0 (1.25")	38.0 (1.48")	3.2 (.12")	1.5 (.06")	3.0 (.12")	1.7 (.07")
158-43	VG 95343 T06 C 002 A	60.0 (2.34")	35.0 (1.37")	60.0 (2.34")	16.0 (.62")	130.0 (5.07")	72.0 (2.81")	38.0 (1.48")	3.2 (.12")	1.5 (.06")	3.0 (.12")	1.7 (.07")
159-41	VG 95343 T06 A 008 A	66.0 (2.57")	45.0 (1.76")	66.0 (2.57")	17.0 (.66")	130.0 (5.07")	50.0 (1.95")	50.0 (1.95")	3.8 (.15")	2.0 (.08")	3.0 (.12")	2.0 (.08")
159-42	VG 95343 T06 B 008 A	66.0 (2.57")	45.0 (1.76")	66.0 (2.57")	17.0 (.66")	150.0 (5.85")	70.0 (2.73")	50.0 (1.95")	3.8 (.15")	2.0 (.08")	3.0 (.12")	2.0 (.08")
159-43	VG 95343 T06 C 003 A	66.0 (2.57")	45.0 (1.76")	66.0 (2.57")	17.0 (.66")	171.0 (6.67")	90.0 (3.51")	50.0 (1.95")	3.8 (.15")	2.0 (.08")	3.0 (.12")	2.0 (.08")
160-41	VG 95343 T06 A 009 A	82.0 (3.2")	58.0 (2.26")	82.0 (3.2")	27.0 (1.05")	137.0 (5.34")	37.0 (1.44")	62.0 (2.42")	3.8 (.15")	3.8 (.15")	3.0 (.12")	2.0 (.08")
160-42	VG 95343 T06 B 009 A	82.0 (3.2")	58.0 (2.26")	82.0 (3.2")	27.0 (1.05")	158.0 (6.16")	58.0 (2.26")	62.0 (2.42")	3.8 (.15")	3.8 (.15")	3.0 (.12")	2.0 (.08")
160-43	VG 95343 T06 C 004 A	82.0 (3.2")	58.0 (2.26")	82.0 (3.2")	27.0 (1.05")	213.0 (8.31")	113.0 (4.41")	62.0 (2.42")	3.8 (.15")	3.8 (.15")	3.0 (.12")	2.0 (.08")

Dimensions in mm, inches in brackets. Subject to technical changes.

Combinations "On request"					
Adhesive	Material				
	B7	G	J	H	L
WM250	•	•	•	•	-
W8	•	•	•	•	-
W24	•	•	•	•	•
W21	•	•	•	•	-
HMT200A	•	•	•	•	-
V9500	•	•	•	•	•
Without Adhesive	•	•	•	•	•

Standard Combinations	
Type	Article Number
152-41-G	401-52780
152-42-G	401-52880
153-41-G	401-53780
153-42-G	401-53880
154-41-G	401-54780
154-42-G	401-54880
155-41-G	401-55780
155-42-G	401-55880
156-41-G	401-56780
156-42-G	401-56880
157-42-G	401-57880
157-43-G	401-57980
158-41-G	401-58780
158-43-G	401-58980
159-41-G	401-59780
159-42-G	401-59880
159-43-G	401-59980
160-41-G	401-60780
160-42-G	401-60880
160-43-G	401-60980



### Bottle Shapes, MIL style

#### Helashrink 100 Series, with rib

- With circular grooved adaptor for strain relief
- Combine with complementary adhesives for environmental sealing



For Material / Adhesive selection and other information please refer to page 10.



100 series supplied / fully recovered.

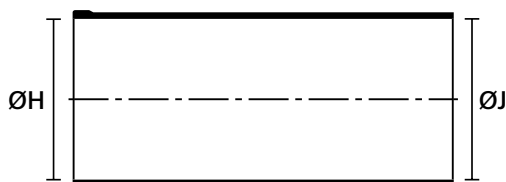

a: Expanded form (supplied)

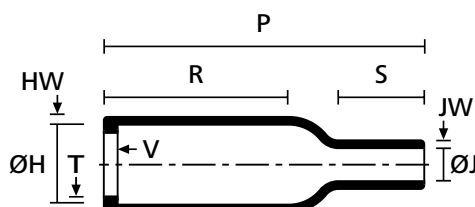

b: Fully recovered form (after heating)

TYPE	Designation as per AS/VG-Norm	ØH min. a	ØH max. b	ØJ min. a	ØJ max. b	P ± 10%	R ± 10%	HW ± 20%	JW ± 20%	V ± 10%	T ± 20%	S nom.
101-4	AS85049/14003HU	31.0 (1.21")	17.8 (.69")	31.0 (1.21")	7.1 (.28")	67.0 (2.61")	38.1 (1.49")	2.0 (.08")	2.0 (.08")	3.0 (.12")	1.0 (.04")	17.8 (.69")
102-4	AS85049/14004HU	36.1 (1.41")	22.4 (.87")	36.1 (1.41")	8.4 (.33")	73.7 (2.87")	43.2 (1.68")	1.8 (.07")	1.8 (.07")	3.0 (.12")	1.0 (.04")	21 (.82")
103-4	AS85049/14005HU	42.7 (1.67")	28.2 (1.1")	42.7 (1.67")	9.9 (.39")	99.1 (3.86")	54.0 (2.11")	2.0 (.08")	2.0 (.08")	3.0 (.12")	1.7 (.07")	24 (.94")
104-4		16.5 (.64")	7.9 (.31")	16.5 (.64")	3.8 (.15")	25.4 (.99")	14.2 (.55")	1.3 (.05")	1.3 (.05")	3.0 (.12")	1.0 (.04")	6.9 (.27")
105-4	AS85049/14001HU	23.4 (.91")	10.4 (.41")	23.4 (.91")	5.6 (.22")	38.1 (1.49")	14.2 (.55")	1.5 (.06")	1.5 (.06")	3.0 (.12")	1.0 (.04")	10.2 (.4")
106-4		31.0 (1.21")	14.2 (.55")	31.0 (1.21")	6.6 (.26")	55.4 (2.16")	22.9 (.89")	1.8 (.07")	1.8 (.07")	3.0 (.12")	1.0 (.04")	10.2 (.4")
107-4	AS85049/14006HU	51.9 (2.02")	35.1 (1.37")	51.9 (2.02")	15.8 (.62")	124.5 (4.86")	66.0 (2.57")	3.1 (.12")	3.1 (.12")	3.0 (.12")	1.7 (.07")	40.6 (1.58")
113-4		10.7 (.42")	7.9 (.31")	4.6 (.18")	2.0 (.08")	25.4 (.99")	14.5 (.57")	1.3 (.05")	1.0 (.04")	3.0 (.12")	1.0 (.04")	4.6 (.18")
118-4	AS85049/14007HU	66.0 (2.57")	44.4 (1.73")	66.0 (2.57")	20.3 (.79")	160.5 (6.26")	91.4 (3.56")	3.8 (.15")	3.8 (.15")	3.0 (.12")	2.0 (.08")	48.3 (1.88")
1009-1		9.0 (.35")	5.6 (.22")	4.0 (.16")	3.2 (.12")	27.0 (1.05")	14.0 (.55")	1.0 (.04")	0.5 (.02")	1.6 (.06")	0.9 (.04")	7.5 (.29")
1030-4		12.0 (.47")	9.8 (.38")	6.0 (.23")	2.0 (.08")	19.0 (.74")	8.0 (.31")	1.0 (.04")	0.5 (.02")	1.5 (.06")	0.5 (.02")	4.6 (.18")
1031-4		12.0 (.47")	9.8 (.38")	6.0 (.23")	2.0 (.08")	15.0 (.59")	4.0 (.16")	1.0 (.04")	0.5 (.02")	1.5 (.06")	0.5 (.02")	4.6 (.18")
1037-4		9.0 (.35")	5.6 (.22")	9.0 (.35")	2.0 (.08")	19.0 (.74")	9.0 (.35")	1.0 (.04")	0.6 (.02")	1.5 (.06")	0.6 (.02")	4.5 (.18")

Dimensions in mm, inches in brackets. Subject to technical changes.



## Bottle Shapes, MIL style

Helashrink 100 Series, with rib

Combinations "On request"					
Adhesive	Material				
	B7	G	J	H	L
WM250	.	.	.	.	-
W8	.	.	.	.	-
W24	.	.	.	.	.
W21	.	.	.	.	-
HMT200A	.	.	.	.	-
V9500	.	.	.	.	.
Without Adhesive	.	.	.	.	.

Standard Combinations	
Type	Article Number
101-4-G	401-01037
102-4-G	401-02031
103-4-G	401-03041
104-4-G	401-04024
105-4-G	401-05034
106-4-G	401-06036
107-4-G	401-07030
113-4-G	401-13480
118-4-B7	401-18018
1009-1-G	410-09001
1030-4-G	410-30480
1031-4-G	410-31001
1037-4-G	410-37001





### Bottle Shapes

#### Helashrink 100 Series, without rib

- Strain relief for connector cable
- Easy re-entry for repair when combined with hot melt adhesive



**For Material / Adhesive selection and other information please refer to page 10.**



100 series supplied / fully recovered.

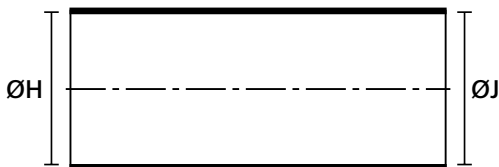

a: Expanded form (supplied)

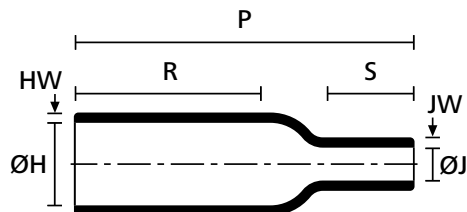

b: Fully recovered form (after heating)

TYPE	ØH min. a	ØH max. b	ØJ min. a	ØJ max. b	P ± 10%	R max.	HW ± 20%	JW ± 30%	S nom.
101-1	31.0 (1.21")	17.8 (.69")	31.0 (1.21")	7.1 (.28")	66.0 (2.57")	38.1 (1.49")	2.0 (.08")	2.0 (.08")	17.8 (.69")
101-2	23.9 (.93")	17.8 (.69")	15.5 (.6")	7.1 (.28")	66.0 (2.57")	38.1 (1.49")	2.0 (.08")	2.0 (.08")	17.8 (.69")
102-1	36.1 (1.41")	22.4 (.87")	36.1 (1.41")	8.4 (.33")	73.7 (2.87")	43.2 (1.68")	1.8 (.07")	1.8 (.07")	17.8 (.69")
102-2	30.0 (1.17")	22.4 (.87")	18.0 (.7")	8.4 (.33")	73.7 (2.87")	43.2 (1.68")	1.8 (.07")	1.8 (.07")	17.8 (.69")
103-1	42.7 (1.67")	28.2 (1.1")	42.7 (1.67")	9.9 (.39")	95.5 (3.72")	54.0 (2.11")	2.0 (.08")	2.0 (.08")	24 (.94")
103-2	37.8 (1.47")	28.2 (1.1")	21.3 (.83")	9.9 (.39")	95.5 (3.72")	54.0 (2.11")	2.0 (.08")	2.0 (.08")	24 (.94")
104-1	16.5 (.64")	7.9 (.31")	16.5 (.64")	3.8 (.15")	25.4 (.99")	14.2 (.55")	1.3 (.05")	1.3 (.05")	6.9 (.27")
104-2	10.7 (.42")	7.9 (.31")	8.4 (.33")	3.8 (.15")	25.4 (.99")	14.2 (.55")	1.3 (.05")	1.3 (.05")	6.9 (.27")
105-1	23.4 (.91")	10.4 (.41")	23.4 (.91")	5.6 (.22")	38.1 (1.49")	22.9 (.89")	1.5 (.06")	1.5 (.06")	10.2 (.4")
106-1	31.0 (1.21")	14.2 (.55")	31.0 (1.21")	6.6 (.26")	55.4 (2.16")	26.5 (1.03")	1.8 (.07")	1.8 (.07")	16.5 (.64")
106-2	19.3 (.75")	14.2 (.55")	14.2 (.55")	6.6 (.26")	55.4 (2.16")	26.5 (1.03")	1.8 (.07")	1.8 (.07")	16.5 (.64")
107-1	51.9 (2.02")	35.1 (1.37")	51.9 (2.02")	15.8 (.62")	124.5 (4.86")	66.0 (2.57")	3.1 (.12")	3.1 (.12")	40.6 (1.58")
107-2	46.9 (1.83")	35.1 (1.37")	35.6 (1.39")	15.8 (.62")	124.5 (4.86")	66.0 (2.57")	3.1 (.12")	3.1 (.12")	40.6 (1.58")
108-1	13.7 (.53")	10.4 (.41")	6.6 (.26")	3.1 (.12")	38.1 (1.49")	22.9 (.89")	1.5 (.06")	1.0 (.04")	7.6 (.3")
108-2	27.9 (1.09")	10.4 (.41")	7.9 (.31")	3.1 (.12")	38.1 (1.49")	22.9 (.89")	1.5 (.06")	1.0 (.04")	7.6 (.3")
109-1	19.3 (.75")	14.2 (.55")	8.1 (.32")	4.1 (.16")	53.3 (2.08")	35.6 (1.39")	2.0 (.08")	1.3 (.05")	7.6 (.3")

Dimensions in mm, inches in brackets. Subject to technical changes.





## Bottle Shapes

## Helashrink 100 Series

TYPE	ØH min. a	ØH max. b	ØJ min. a	ØJ max. b	P ± 10%	R max.	HW ± 20%	JW ± 30%	S nom.
109-2	38.1 (1.49")	14.2 (.55")	11.7 (.46")	4.1 (.16")	53.3 (2.08")	35.6 (1.39")	2.0 (.08")	1.3 (.05")	7.6 (.3")
110-1	23.9 (.93")	17.8 (.69")	11.7 (.46")	5.6 (.22")	63.5 (2.48")	38.1 (1.49")	2.5 (.1")	1.5 (.06")	12.7 (.5")
110-2	50.8 (1.98")	17.8 (.69")	17.0 (.66")	5.6 (.22")	63.5 (2.48")	38.1 (1.49")	2.5 (.1")	1.5 (.06")	12.7 (.5")
111-1	30.0 (1.17")	22.4 (.87")	14.7 (.57")	7.1 (.28")	76.2 (2.97")	43.2 (1.68")	3.1 (.12")	1.8 (.07")	15.2 (.59")
111-2	63.5 (2.48")	22.4 (.87")	21.3 (.83")	7.1 (.28")	76.2 (2.97")	43.2 (1.68")	3.1 (.12")	1.8 (.07")	15.2 (.59")
116-1	59.4 (2.32")	44.5 (1.74")	43.7 (1.7")	20.8 (.81")	158.8 (6.19")	91.4 (3.56")	5.6 (.22")	4.6 (.18")	41.9 (1.63")
118-1	66.0 (2.57")	44.4 (1.73")	66.0 (2.57")	20.3 (.79")	150.0 (5.85")	80.0 (3.12")	3.8 (.15")	3.8 (.15")	48.3 (1.88")
119-1	86.4 (3.37")	57.2 (2.23")	86.4 (3.37")	26.6 (1.04")	209.6 (8.17")	118.1 (4.61")	4.6 (.18")	4.6 (.18")	61 (2.38")
1006-1	40.0 (1.56")	20.0 (.78")	20.0 (.78")	6.0 (.23")	78.8 (3.07")	30.0 (1.17")	1.5 (.06")	1.0 (.04")	20 (.78")

Dimensions in mm, inches in brackets. Subject to technical changes.

Standard Combinations	
Type	Article Number
101-1-G	401-01006
101-2-G	401-01026
102-1-G	401-02005
102-2-G	401-02020
103-1-G	401-03006
103-2-B7	401-03024
104-1-G	401-04006
104-2-G	401-04017
105-1-G	401-05005
106-1-G	401-06005
106-2-G	401-06023
107-1-G	401-07006
107-2-B7	401-07016
108-1-B7	401-08001
108-2-G	401-08016
109-1-B7	401-09002
109-2-G	401-09011
110-1-G	401-10005
110-2-G	401-10011
111-1-J	401-11003
111-2-G	401-11011
118-1-G	401-18005
119-1-B7	401-19001
1006-1-B7	410-06006
116-1-B7.	401-16007

Combinations "On request"					
Adhesive	Material				
	B7	G	J	H	L
WM250	•	•	•	•	-
W8	•	•	•	•	-
W24	•	•	•	•	•
W21	-	-	-	•	-
HMT200A	•	•	•	•	-
V9500	•	•	•	•	•
Without Adhesive	•	•	•	•	-



### Bottle Shapes

#### Helashrink 120 Series, without rib

- This style has a long tail providing extended strain relief for small diameter wires
- Supplied without rib and in various material / adhesive combinations to meet your requirement



For Material / Adhesive selection and other information please refer to page 10.



120-42-G supplied / fully recovered.

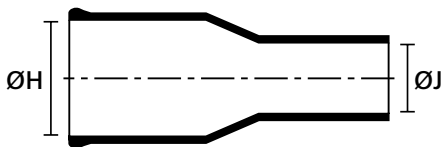

a: Expanded form (supplied)

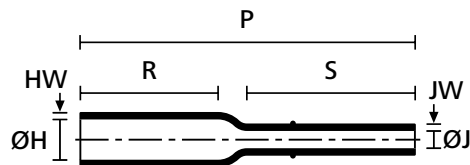

Fully recovered form without end ribs (after heating)

TYPE	ØH min. a	ØH max. b	ØJ min. a	ØJ max. b	P ± 10%	R ± 10%	W ± 20%	HW ± 20%	JW ± 20%	S nom.
120-1	16.5 (.64")	7.0 (.27")	10.2 (.4")	3.0 (.12")	60.9 (2.38")	24.0 (.94")	1.3 (.05")	1.3 (.05")	1.3 (.05")	32.0 (1.25")
120-2	20.3 (.79")	7.0 (.27")	10.2 (.4")	3.0 (.12")	60.9 (2.38")	24.0 (.94")	1.3 (.05")	1.3 (.05")	1.3 (.05")	32.0 (1.25")
120-3	16.5 (.64")	7.0 (.27")	10.7 (.42")	3.0 (.12")	38.0 (1.48")	24.0 (.94")	1.3 (.05")	1.3 (.05")	1.3 (.05")	9.1 (.35")

Dimensions in mm, inches in brackets. Subject to technical changes.

#### Helashrink 120 Series, with rib

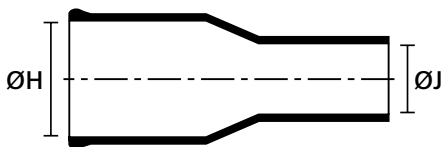

a: Expanded form (supplied)

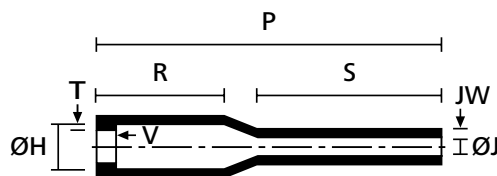

b: Fully recovered form with end ribs (after heating)

TYPE	ØH min. a	ØH max. b	ØJ min. a	ØJ max. b	P ± 10%	R ± 10%	HW ± 20%	JW ± 20%	V ± 10%	T ± 10%	S nom.
120-41	16.5 (.64")	7.0 (.27")	10.7 (.42")	3.0 (.12")	38.0 (1.48")	24.0 (.94")	1.3 (.05")	1.3 (.05")	3.0 (.12")	1.0 (.04")	32.0 (1.25")
120-42	16.5 (.64")	7.0 (.27")	10.2 (.4")	3.0 (.12")	60.9 (2.38")	24.0 (.94")	1.3 (.05")	1.3 (.05")	3.0 (.12")	1.0 (.04")	32.0 (1.26")

Dimensions in mm, inches in brackets. Subject to technical changes.

Standard Combinations	
Type	Article Number
120-1-G	401-20003
120-2-G	401-20014
120-3-G	401-20020

Standard Combinations	
Type	Article Number
120-41-G	401-20022
120-42-G	401-20026



### Long Outlet Shape, VG style

#### Helashrink 130 Series, with rib, low profile

- Low profile and lightweight
- Typically used on airborne harnesses
- Rib locates on circular backshell



**For Material / Adhesive selection and other information please refer to page 10.**



135-1 supplied / fully recovered.

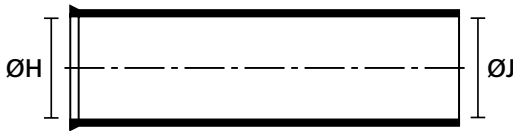

a: Expanded form (supplied)

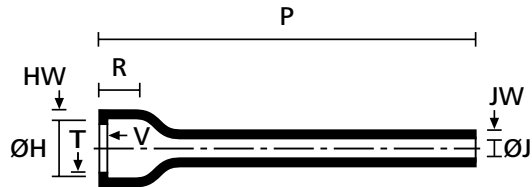

b: Fully recovered form (after heating)

TYPE	Designation as per AS/VG-Norm	ØH min. a	ØH max. b	ØJ min. a	ØJ max. b	P ± 10%	R ± 10%	HW ± 20%	JW ± 20%	V ± 10%	T ± 10%
129-1	VG 95343 T06 D 001 A	22.0 (.86")	12.0 (.47")	22.0 (.86")	6.5 (.25")	76.0 (2.96")	12.0 (.47")	1.5 (.06")	1.1 (.04")	3.0 (.12")	1.0 (.04")
129-4	AS85049/14009HU	22.3 (.87")	11.4 (.44")	22.3 (.87")	6.5 (.25")	105.9 (4.13")	11.7 (.46")	1.5 (.06")	1.1 (.04")	3.0 (.12")	1.0 (.04")
130-1	VG 95343 T06 D 002 A	25.5 (.99")	15.0 (.59")	25.5 (.99")	7.5 (.29")	83.0 (3.24")	12.0 (.47")	1.5 (.06")	1.1 (.04")	3.0 (.12")	1.0 (.04")
130-4	AS85049/14010HU	25.6 (1")	15.0 (.59")	25.6 (1")	7.4 (.29")	121.2 (4.73")	12.2 (.48")	1.5 (.06")	1.1 (.04")	3.0 (.12")	1.0 (.04")
131-1	VG 95343 T06 D 003 A	29.0 (1.13")	19.0 (.74")	29.0 (1.13")	8.5 (.33")	89.0 (3.47")	12.0 (.47")	1.8 (.07")	1.1 (.04")	3.0 (.12")	1.0 (.04")
131-4	AS85049/14011HU	29.4 (1.15")	18.8 (.73")	29.4 (1.15")	8.4 (.33")	138.7 (5.41")	12.2 (.48")	1.8 (.07")	1.1 (.04")	1.0 (.04")	1.0 (.04")
132-1	VG 95343 T06 D 004 A	34.0 (1.33")	23.0 (.9")	34.0 (1.33")	10.0 (.39")	102.0 (3.98")	12.0 (.47")	1.8 (.07")	1.1 (.04")	3.0 (.12")	1.0 (0.39")
132-2		34.0 (1.33")	22.9 (.89")	34.0 (1.33")	9.7 (.38")	35.0 (1.37")	12.2 (.48")	1.8 (.07")	1.1 (.04")	3.0 (.12")	1.0 (.04")
132-4	AS85049/14012HU	34.0 (1.33")	22.9 (.89")	34.0 (1.33")	9.7 (.38")	159.5 (6.22")	12.2 (.48")	1.8 (.07")	1.1 (.04")	3.0 (.12")	1.0 (.04")
133-1	VG 95343 T06 D 005 A	37.0 (1.44")	30.0 (1.17")	37.0 (1.44")	11.0 (.43")	108.0 (4.21")	14.0 (.55")	2.0 (.08")	1.1 (.04")	3.0 (.12")	1.7 (.07")
133-2		37.3 (1.45")	26.9 (1.05")	37.3 (1.45")	10.4 (.41")	47.0 (1.83")	14.0 (.55")	2.0 (.08")	1.1 (.04")	3.0 (.12")	1.7 (.07")
133-3		37.3 (1.45")	29.5 (1.15")	37.3 (1.45")	10.4 (.41")	60.0 (2.34")	14.0 (.55")	2.0 (.08")	1.1 (.04")	3.0 (.12")	1.7 (.07")
133-4	AS85049/14013HU	37.3 (1.45")	26.9 (1.05")	37.3 (1.45")	10.4 (.41")	177.8 (6.93")	14.0 (.55")	2.0 (.08")	1.1 (.04")	3.0 (.12")	1.7 (.07")
134-1	VG 95343 T06 D 006 A	43.5 (1.7")	34.0 (1.33")	43.5 (1.7")	12.0 (.47")	114.0 (4.45")	15.0 (.59")	2.0 (.08")	1.1 (.04")	3.0 (.12")	1.7 (.07")
134-4	AS85049/14014HU	43.7 (1.7")	34.0 (1.33")	43.7 (1.7")	12.2 (.48")	203.2 (7.92")	15.2 (.59")	2.0 (.08")	1.1 (.04")	3.0 (.12")	1.7 (.07")
135-1	VG 95343 T06 D 007 A	50.0 (1.95")	41.0 (1.6")	50.0 (1.95")	14.5 (.57")	118.0 (4.6")	15.0 (.59")	2.3 (.09")	1.4 (.05")	3.0 (.12")	1.7 (.07")
135-4	AS85049/14015HU	50.0 (1.95")	41.2 (1.61")	50.0 (1.95")	14.2 (.55")	203.2 (7.92")	15.2 (.59")	2.3 (.09")	1.4 (.05")	3.0 (.12")	1.7 (.07")

Dimensions in mm, inches in brackets. Subject to technical changes.

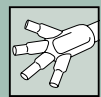

### Long Outlet Shape, VG style

Helashrink 130 Series, with rib, low profile

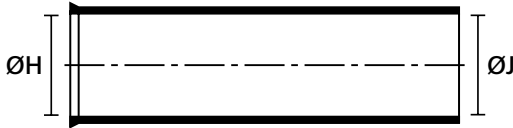

a: Expanded form (supplied)

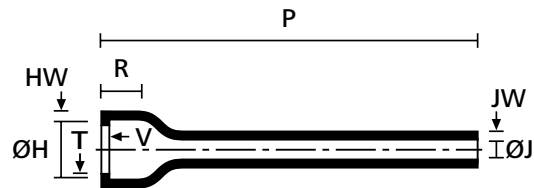

b: Fully recovered form (after heating)

TYPE	Designation as per AS/VG-Norm	ØH min. a	ØH max. b	ØJ min. a	ØJ max. b	P ± 10%	R ± 10%	HW ± 20%	JW ± 20%	V ± 10%	T ± 10%
136-1	VG 95343 T06 D 008 A	62.5 (2.44")	47.0 (1.83")	62.5 (2.44")	18.0 (.7")	121.0 (4.72")	16.0 (.62")	2.5 (.1")	1.4 (.05")	3.0 (.12")	2.0 (.08")
136-2		70.0 (2.73")	47.0 (1.83")	70.0 (2.73")	17.5 (.68")	125.0 (4.88")	16.0 (.62")	2.5 (.1")	1.4 (.05")	3.0 (.12")	2.0 (.08")
136-4	AS85049/14016HU	62.7 (2.45")	47.0 (1.83")	62.7 (2.45")	17.5 (.68")	203.2 (7.92")	16.0 (.62")	2.5 (.1")	1.4 (.05")	3.0 (.12")	2.0 (.08")
138-1	VG 95343 T06 D 009 A	69.0 (2.69")	60.0 (2.34")	69.0 (2.69")	20.0 (.78")	127.0 (4.95")	16.0 (.62")	2.5 (.1")	1.4 (.05")	3.0 (.12")	2.0 (.08")
138-4	AS85049/14017HU	69.3 (2.73")	59.7 (2.35")	69.3 (2.73")	19.6 (.77")	203.2 (8.00")	-	2.5 (.10")	1.4 (.055")	-	-

Dimensions in mm, inches in brackets. Subject to technical changes.

Combinations "On request"					
Adhesive	Material				
	B7	G	J	H	L
WM250	•	•	•	•	-
W8	•	•	•	•	-
W24	•	•	•	•	•
W21	•	•	•	•	-
HMT200A	•	•	•	•	-
V9500	•	•	•	•	•
Without Adhesive	•	•	•	•	•

Standard Combinations	
Type	Article Number
129-4-G	401-29025
129-1-G	401-29180
130-4-G	401-30021
130-1-G	401-30180
131-4-G	401-31028
131-1-G	401-31180
132-2-G	401-32014
132-4-G	401-32030
132-1-G	401-32180
133-2-JWM250	401-33008
133-4-G	401-33021
133-3-B7WM250	401-33036
133-1-G	401-33180
134-4-G	401-34015
134-1-G	401-34180
135-4-G	401-35009
135-1-G	401-35180
136-4-G	401-36006
136-2-JW8	401-36024
136-1-G	401-36180
138-1-G	401-38180



### Long Outlet Shapes

#### Helashrink 140 Series, without rib

- Low profile and light weight
- Suited for aerospace harness assemblies
- Extended tail provides excellent strain relief and flexibility



146-1 supplied / fully recovered.

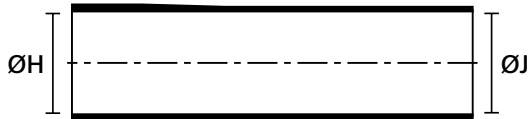

a: Expanded form (supplied)

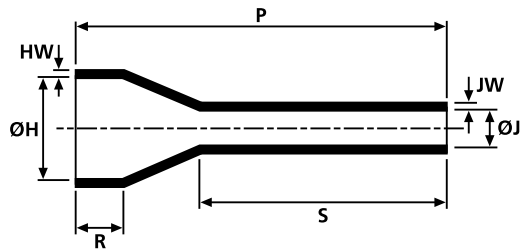

b: Fully recovered form (after heating)

TYPE	ØH min. a	ØH max. b	ØJ min. a	ØJ max. b	P ± 10%	R ± 10%	HW ± 20%	JW ± 30%	S nom.
146-1	20.1 (.78")	14.5 (.57")	20.1 (.78")	5.3 (.21")	127.0 (4.95")	15.7 (.61")	2.0 (.08")	2.0 (.08")	97.0 (3.78")
146-2	22.3 (.87")	14.5 (.57")	10.2 (.4")	5.3 (.21")	127.0 (4.95")	15.7 (.61")	2.0 (.08")	2.0 (.08")	97.0 (3.78")
148-1	30.5 (1.19")	18.0 (.7")	30.5 (1.19")	7.9 (.31")	146.0 (5.69")	15.7 (.61")	2.0 (.08")	2.0 (.08")	125.0 (4.88")
148-2	30.5 (1.19")	18.0 (.7")	15.2 (.59")	7.9 (.31")	146.0 (5.69")	15.7 (.61")	2.3 (.09")	2.3 (.09")	125.0 (4.88")
149-1	41.2 (1.61")	21.8 (.85")	41.2 (1.61")	10.2 (.4")	162.1 (6.32")	22.4 (.87")	2.3 (.09")	2.3 (.09")	127.0 (4.95")

Dimensions in mm, inches in brackets. Subject to technical changes.

Combinations "On request"					
Adhesive	Material				
	B7	G	J	H	L
WM250	•	•	•	•	-
W8	•	•	•	•	-
W24	•	•	•	•	•
W21	-	-	-	•	-
HMT200A	-	•	•	•	-
V9500	•	•	•	•	•
Without Adhesive	•	•	•	•	•

Standard Combinations	
Type	Article Number
146-1-B7	401-46001
146-2-G	401-46009
148-1-G	401-48006
148-2-J	401-48016
149-1-J	401-49006



### Bottle Shapes

#### Helashrink 160 Series, without rib

- This style is a straight boot used for cable strain relief and environmental protection on many applications
- Ideally suited where space is a premium



For Material / Adhesive selection and other information please refer to page 10.



162-1-G supplied / fully recovered.

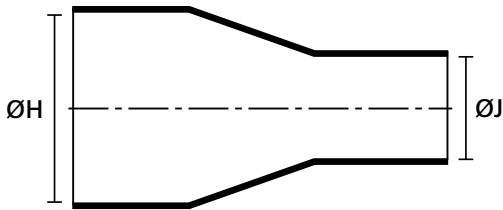

a: Expanded form (supplied)

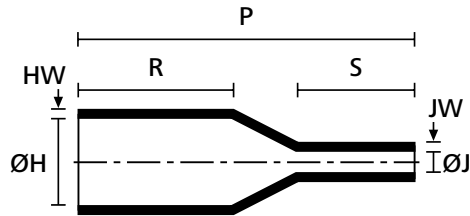

b: Fully recovered form (after heating)

TYPE	ØH min. a	ØH max. b	ØJ min. a	ØJ max. b	P ± 10%	R ± 10%	HW ± 20%	JW ± 20%	S nom.
162-1	22.0 (.86")	14.2 (.55")	9.0 (.35")	4.1 (.16")	44.0 (1.72")	15.7 (.61")	1.8 (.07")	1.8 (.07")	16.0 (.62")

Dimensions in mm, inches in brackets. Subject to technical changes.

Combinations "On request"				
Adhesive	Material			
	B7	G	J	H
WM250	•	•	•	•
W8	•	•	•	•
W24	•	•	•	•
W21	-	-	-	•
HMT200A	•	•	•	•
V9500	•	•	•	•
Without Adhesive	•	•	•	•

Standard Combinations	
Type	Article Number
162-1-G	401-62180



### Bottle Shapes, VG style

#### Helashrink 170 Series, with rib

- Cable strain relief for partially loaded connectors
- Small cable diameters
- Use with our W24 adhesive for excellent chemical resistance



177-1-G supplied / fully recovered.

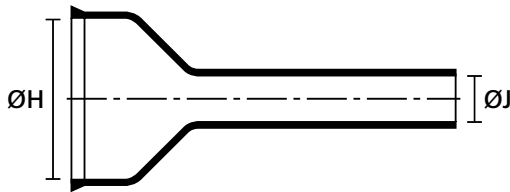

a: Expanded form (supplied)

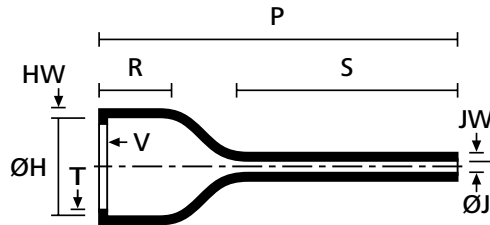

b: Fully recovered form (after heating)

TYPE	Designation as per AS/VG-Norm	ØH min. a	ØH max. b	ØJ min. a	ØJ max. b	P ± 10%	R ± 10%	T ± 20%	JW nom.	HW ± 20%	V max.	S nom.
176-1	VG 95343 T06 D 011 A	19.3 (.75")	13.0 (.51")	6.3 (.25")	2.1 (.08")	60.0 (2.34")	11.7 (.46")	1.0 (.04")	1.1 (.04")	1.5 (.06")	3.3 (.13")	38.0 (1.48")
176-2		19.0 (.74")	13.0 (.51")	6.0 (.23")	2.0 (.08")	30.0 (1.17")	11.7 (.46")	1.0 (.04")	1.1 (.04")	1.5 (.06")	3.3 (.13")	8.0 (.31")
176-3		25.0 (.98")	13.0 (.51")	4.0 (.16")	2.0 (.08")	45.0 (1.76")	11.7 (.46")	1.0 (.04")	1.1 (.04")	1.5 (.06")	3.3 (.13")	23.0 (.9")
176-4	AS85049/14019HU	19.0 (.74")	13.0 (.51")	6.0 (.23")	2.0 (.08")	60.0 (2.34")	11.7 (.46")	1.0 (.04")	1.1 (.04")	1.5 (.06")	3.3 (.13")	38.0 (1.48")
177-1	AS85049/14020HU	26.1 (1.02")	19.1 (.75")	7.6 (.30")	2.6 (.10")	74.2 (2.91")	12.2 (.48")	1.0 (.04")	1.1 (.04")	1.8 (.07")	3.3 (.13")	45.0 (1.77")
178-1	AS85049/14021HU	34.2 (1.33")	26.0 (1.01")	9.6 (.37")	3.1 (.12")	84.0 (3.28")	12.2 (.48")	1.0 (.04")	1.1 (.04")	1.8 (.07")	3.3 (.13")	51.0 (1.99")
	VG 95343 T06 D 013 A											
179-1	AS85049/14022HU	43.6 (1.7")	34.1 (1.33")	11.4 (.44")	3.6 (.14")	100.0 (3.9")	12.2 (.48")	1.7 (.07")	1.1 (.04")	1.8 (.07")	3.3 (.13")	58.0 (2.26")
	VG 95343 T06 D 014 A											

Dimensions in mm, inches in brackets. Subject to technical changes.

Combinations "On request"					
Adhesive	Material				
	B7	G	J	H	L
WM250	•	•	•	•	-
W8	•	•	•	•	-
W24	•	•	•	•	•
W21	-	-	-	•	-
HMT200A	•	•	•	•	-
V9500	•	•	•	•	•
Without Adhesive	•	•	•	•	•

Standard Combinations	
Type	Article Number
176-2-B7	401-76014
176-3-G	401-76018
176-4-J	401-76022
176-1-G	401-76180
178-1-G	401-78180
179-1-G	401-79180





### Bottle Shapes, VG style

#### Helashrink 190 Series, with external ribs

- Specifically for small audio connectors
- Multiple external ribs to improve grip in harsh conditions



For Material / Adhesive selection and other information please refer to page 10.



199-4-G supplied / fully recovered.

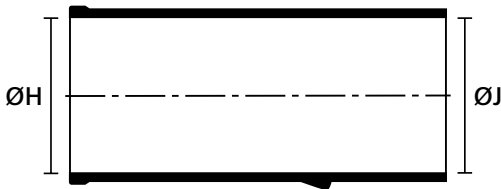

a: Expanded form (supplied)

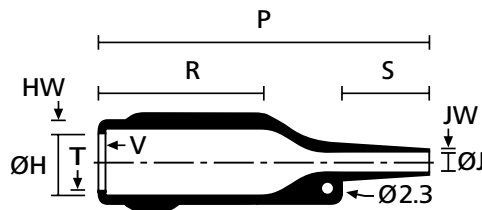

b: Fully recovered form (after heating)

TYPE	Designation as per AS/VG-Norm	ØH min. a	ØH max. b	ØJ min. a	ØJ max. b	P ± 10%	R ± 10%	HW ± 20%	JW ± 20%	V ± 10%	T ± 10%	T ± 20%	S nom.
199-4	VG 95343 T06 A 010 A	17.5 (.68")	14.0 (.55")	7.0 (.27")	4.3 (.17")	70.0 (2.73")	35.0 (1.37")	1.8 (.07")	0.5 (.02")	1.5 (.06")	-	1.0 (.04")	20.0 (.78")
199-6		18.5 (.72")	14.0 (.55")	18.5 (.72")	4.3 (.17")	70.0 (2.73")	35.0 (1.37")	1.8 (.07")	0.5 (.02")	1.5 (.06")	1.0 (.04")	1.0 (.04")	20.0 (.78")

Dimensions in mm, inches in brackets. Subject to technical changes.

Combinations "On request"				
Adhesive	Material			
	B7	G	J	H
WM250	•	•	•	•
W8	•	•	•	•
W24	•	•	•	•
W21	-	-	-	•
HMT200A	•	•	•	•
V9500	•	•	•	•
Without Adhesive	•	•	•	•

Standard Combinations	
Type	Article Number
199-4-G	401-99480
199-6-G	401-99007



### 2-Way Outlet Shapes

#### Helashrink 200 Series, low profile

- For harnesses which route multi-core cables in different directions
- High ratio expansion for quick and easy installation
- Mechanical tension relief



200 series supplied / fully recovered.

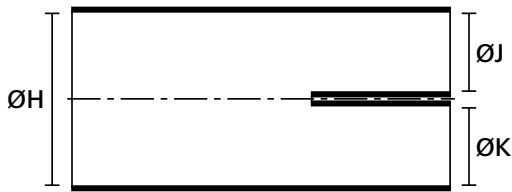

a: Expanded form (supplied)

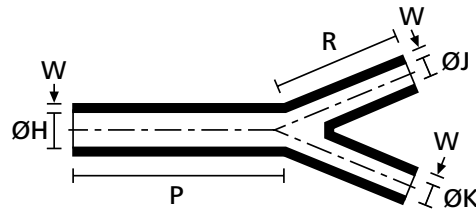

b: Fully recovered form (after heating)

TYPE	ØH min. a	ØH max. b	ØJ min. a	ØJ max. b	ØK min. a	ØK max. b	P ± 10%	R ± 10%	W ± 20%
201-1	19.0 (.74")	9.4 (.37")	6.4 (.25")	14.0 (.55")	6.4 (.25")	14.0 (.55")	50.8 (1.98")	30.5 (1.19")	1.5 (.06")
201-3	24.5 (.96")	9.4 (.37")	14.0 (.55")	6.4 (.25")	14.0 (.55")	6.4 (.25")	50.8 (1.98")	30.5 (1.19")	1.5 (.06")
202-1	19.0 (.74")	9.4 (.37")	7.6 (.3")	3.8 (.15")	7.6 (.3")	3.8 (.15")	50.8 (1.98")	30.5 (1.19")	1.5 (.06")
202-2	20.0 (.78")	9.4 (.37")	12.5 (.49")	3.8 (.15")	12.5 (.49")	3.8 (.15")	50.8 (1.98")	30.5 (1.19")	1.5 (.06")
202-3	24.5 (.96")	9.4 (.37")	16.0 (.62")	3.8 (.15")	16.0 (.62")	3.8 (.15")	50.8 (1.98")	30.5 (1.19")	1.5 (.06")

Dimensions in mm, inches in brackets. Subject to technical changes.

Combinations "On request"				
Adhesive	Material			
	B7	G	J	H
WM250	•	•	•	•
W8	•	•	•	•
W24	•	•	•	•
W21	-	-	-	-
HMT200A	•	•	•	-
V9500	•	•	•	-
Without Adhesive	•	•	•	•

Standard Combinations	
Type	Article Number
201-3-G	402-01020
201-1-G	402-01180
202-1-G	402-02004
202-2-G	402-02011
202-3-G	402-02019



### 2-Way Outlet Shapes, VG style

#### Helashrink 200 Series

- Mechanical tension relief in cable harnesses



For Material / Adhesive selection and other information please refer to page 10.



203-1 supplied / fully recovered.

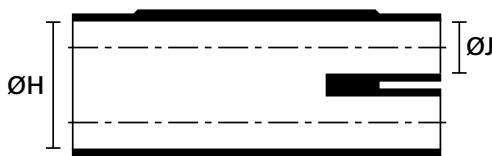

a: Expanded form (supplied)

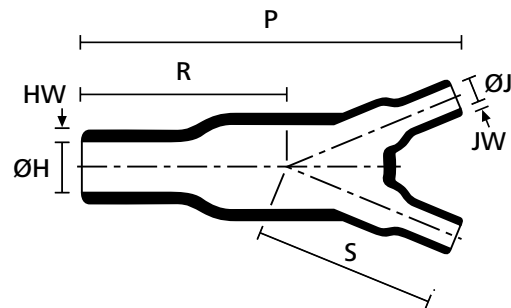

b: Fully recovered form (after heating)

TYPE	Designation as per AS/VG-Norm	ØH min. a	ØH max. b	ØJ min. a	ØJ max. b	P ± 10%	R ± 10%	HW ± 20%	JW nom.	S nom.
203-1	AS85049/14206HU	27.0 (1.05")	12.0 (.47")	13.0 (.51")	6.0 (.23")	80.0 (3.15")	43.0 (1.68")	2.5 (.1")	1.5 (.06")	43.0 (1.68")
	VG 95343 T08 C 002 A									
204-1	AS85049/14207HU	39.0 (1.52")	18.0 (.7")	27.0 (1.05")	12.0 (.47")	66.0 (2.57")	81.0 (3.16")	3.1 (.12")	2.0 (.08")	81.0 (3.16")
	VG 95343 T08 C 003 A									
206-1	AS85049/14205HU	13.0 (.51")	6.0 (.23")	7.0 (.27")	3.0 (.12")	41.0 (1.62")	19.0 (.74")	1.5 (.06")	1.0 (.04")	19.0 (.74")
	VG 95343 T08 C 001 A									
212-1	VG 95343 T08 C 005 A	14.5 (.57")	8.0 (.31")	8.5 (.33")	5.5 (.21")	82.6 (3.22")	83.0 (3.24")	2.3 (.09")	2.0 (.08")	63.0 (2.46")
213-1		17.3 (.67")	7.9 (.31")	11.1 (.43")	7.9 (.31")	140.0 (5.46")	83.1 (3.24")	2.3 (.09")	1.0 (.04")	64.0 (2.5")
213-2		40.0 (1.56")	8.5 (.33")	31.8 (1.24")	7.9 (.31")	140.0 (5.46")	83.1 (3.24")	2.3 (.09")	2.3 (.09")	64.0 (2.5")

Dimensions in mm, inches in brackets. Subject to technical changes.

Combinations "On request"					
Adhesive	Material				
	B7	G	J	H	L
WM250	•	•	•	•	-
W8	•	•	•	•	-
W24	•	•	•	•	•
W21	-	-	-	•	-
HMT200A	•	•	•	-	-
V9500	•	•	•	-	•
Without Adhesive	•	•	•	•	•

Standard Combinations	
Type	Article Number
203-1-G	402-03180
204-1-G	402-04180
206-1-G	402-06180
212-1-G	402-12180
213-1-G	402-13180
213-2-G	402-13021



## 2-Way Outlet Shapes, Breakout Boots

### Helashrink 200 Series, in line, low voltage

- Easy, time-saving insulation of cable branch point where it splits into single wires
- Adhesive is applied to relieve mechanical tension in cable harnesses

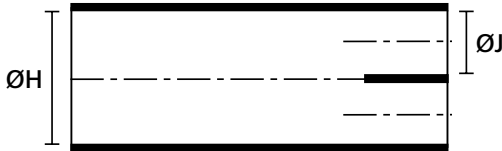

a: Expanded form (supplied)

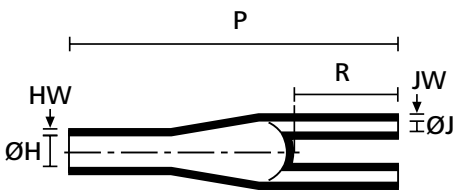

b: Fully recovered form (after heating)



223-2 supplied / fully recovered.

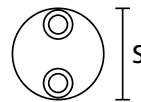

Fully recovered form (after heating)

TYPE	ØH min. a	ØH max. b	ØJ min. a	ØJ max. b	P ± 10%	R ± 10%	HW ± 20%	JW ± 20%	S nom.
216-3	21.0 (.82")	9.4 (.37")	9.0 (.35")	2.8 (.11")	76.5 (2.98")	20.0 (.78")	1.6 (.06")	1.6 (.06")	-
217-2	31.0 (1.21")	15.2 (.59")	13.0 (.51")	4.3 (.17")	99.5 (3.88")	28.5 (1.11")	2.2 (.09")	2.2 (.09")	19.0 (.74")
218-2	49.0 (1.91")	22.9 (.89")	20.0 (.78")	7.6 (.3")	119.0 (4.64")	34.0 (1.33")	3.2 (.12")	3.2 (.12")	-
219-2	77.0 (3")	38.1 (1.49")	37.0 (1.44")	12.7 (.5")	141.5 (5.52")	42.5 (1.66")	3.8 (.15")	3.8 (.15")	44.0 (1.72")
220-1	50.0 (1.95")	28.0 (1.09")	23.0 (.9")	8.0 (.31")	175.0 (6.83")	100.0 (3.9")	2.5 (.1")	2.0 (.08")	33.0 (1.29")

Dimensions in mm, inches in brackets. Subject to technical changes.

Combinations "On request"				
Adhesive	Material			
	B7	G	H	B8
W	•	•	•	•
W2	•	•	•	•
V9500	•	•	-	-
HMT200A	•	•	-	•
W21	-	-	•	-
Without Adhesive	•	•	•	•

Standard Combinations	
Type	Article Number
217-2-B7	402-17014
218-2-B7	402-18020
219-2-B7W	402-19039
220-1-B7	402-20008
216-3-B7	402-16057



### 3-Way Outlet Shapes, VG style

#### Helashrink 300 Series

- Cable strain relief and mechanical protection at harness transition points
- All outlets clearly marked to aid orientation during installation



**For Material / Adhesive selection and other information please refer to page 10.**



304-1-G supplied / fully recovered.

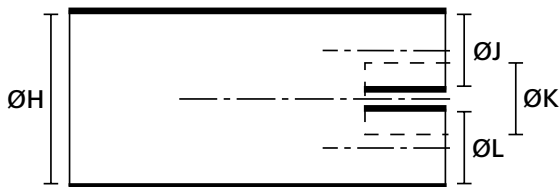

a: Expanded form (supplied)

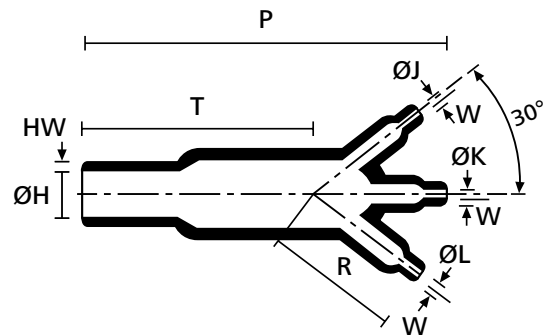

b: Fully recovered form (after heating)

TYPE	Designation as per AS/VG-Norm	ØH min. a	ØH max. b	ØJ/K/L min. a	ØJ/K/L max. b	P ± 10%	R ± 10%	HW ± 20%	W ± 20%	T ± 10%
304-1	AS85049/14210HU	27.0 (1.05")	13.5 (.53")	13.0 (.51")	7.0 (.27")	93.0 (3.63")	50.3 (1.96")	2.5 (.1")	1.5 (.06")	42.9 (1.67")
	VG 95343 T08 D 002 A									
306-1	AS85049/14209HU	13.0 (.51")	6.5 (.25")	6.5 (.25")	3.5 (.14")	46.0 (1.79")	25.4 (.99")	1.3 (.05")	1.0 (.04")	20.3 (.79")
	VG 95343 T08 D 001 A									
310-1	AS85049/14211HU	38.5 (1.5")	19.0 (.74")	19.0 (.74")	10.0 (.39")	135.0 (5.27")	73.7 (2.87")	3.0 (.12")	1.8 (.07")	61.0 (2.38")
	VG 95343 T08 D 003 A									
311-1	AS85049/14212HU	55.5 (2.16")	25.5 (.99")	27.0 (1.05")	12.5 (.49")	192.0 (7.49")	103.1 (4.02")	4.6 (.18")	3.1 (.12")	88.9 (3.47")
	VG 95343 T08 D 004 A									

Dimensions in mm, inches in brackets. Subject to technical changes.

Combinations "On request"					
Adhesive	Material				
	B7	G	J	H	L
WM250	•	•	•	•	-
W8	•	•	•	•	-
W24	•	•	•	•	•
W21	-	-	-	•	-
HMT200A	•	•	•	•	-
V9500	•	•	•	•	•
Without Adhesive	•	•	•	•	•

Standard Combinations	
Type	Article Number
304-1-G	403-04180
306-1-G	403-06180
310-1-G	403-10180
311-1-G	403-11180



### 3-Way Outlet Shapes, Breakout Boots

#### Helashrink 300 Series, in line, low voltage

- Easy, time-saving insulation of cable branch point where it splits into single wires
- Adhesive is applied to relieve mechanical tension in cable harnesses



300 Series supplied / fully recovered.

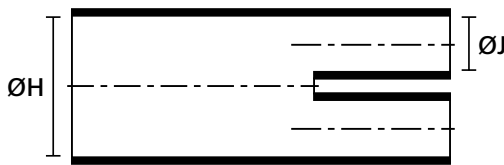

a: Expanded form (supplied)

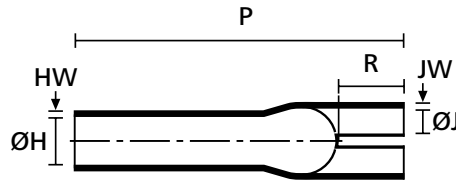

b: Fully recovered form (after heating)

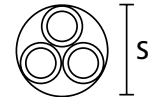

Fully recovered form (after heating)

TYPE	ØH min. a	ØH max. b	ØJ min. a	ØJ max. b	P ± 10%	R ± 10%	HW ± 20%	JW ± 20%	S nom.
318-1	23.0 (.9")	9.1 (.35")	9.0 (.35")	3.0 (.12")	76.5 (2.98")	20.0 (.78")	2.5 (.1")	2.5 (.1")	16.0 (.62")
319-1	31.0 (1.21")	17.5 (.68")	13.0 (.51")	4.6 (.18")	93.5 (3.65")	28.5 (1.11")	2.9 (.11")	2.9 (.11")	23.0 (.9")
328-2	44.0 (1.72")	22.8 (.89")	21.0 (.82")	7.6 (.3")	99.0 (3.86")	34.0 (1.33")	3.8 (.15")	3.8 (.15")	-
330-2	61.0 (2.38")	35.5 (1.38")	32.0 (1.25")	12.7 (.5")	144.5 (5.64")	45.5 (1.77")	3.8 (.15")	3.8 (.15")	47.0 (1.83")
339-2	39.0 (1.52")	12.7 (.5")	17.0 (.66")	4.1 (.16")	102.0 (3.98")	56.0 (2.18")	2.9 (.11")	2.9 (.11")	26.0 (1.01")

Dimensions in mm, inches in brackets. Subject to technical changes.

Combinations "On request"					
Adhesive	Material				
	B7	G	H	B8	J
W	•	•	•	•	•
W2	•	•	•	•	-
WM250	•	•	•	•	•
V9500	•	•	-	-	•
HMT200A	•	•	-	•	•
W21	-	-	•	-	-
Without Adhesive	•	•	•	•	•

Standard Combinations	
Type	Article Number
319-1-G	403-19022
328-2-J	403-28015
330-2-B7WM250	403-30014
339-2-G	403-39017
318-1-G	403-18018



### 4-Way Outlet Shapes, VG style

#### Helashrink 400 Series

- All outlets clearly marked to aid orientation during installation
- Cable strain relief and mechanical protection at harness transition points



**For Material / Adhesive selection and other information please refer to page 10.**



403-1 supplied / fully recovered.

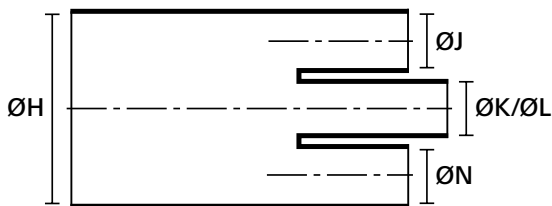

a: Expanded form (supplied)

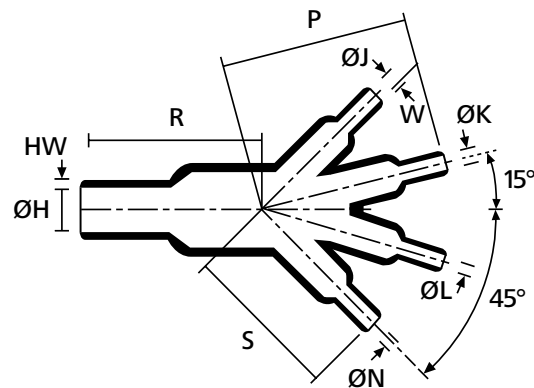

b: Fully recovered form (after heating)

TYPE	Designation as per AS/VG-Norm	ØH min. a	ØH max. b	ØJ/K/L/N min. a	ØJ/K/L/N max. b	P ± 10%	R ± 10%	S ± 10%	W ± 10%	HW ± 20%
403-1	VG 95343 T08 E 004 A	27.0 (1.05")	13.0 (.51")	13.0 (.51")	7.0 (.27")	51.8 (2.02")	49.0 (1.91")	45.0 (1.76")	1.0 (.04")	2.5 (.1")
410-1	VG95343T19E001A	12.0 (.47")	7.0 (.27")	6.6 (.26")	3.5 (.14")	65.0 (2.54")	24.0 (9.4")	24.0 (.94")	1.0 (.04")	1.5 (.06")
411-1	VG 95343 T08 E 002 A	19.0 (.74")	10.0 (.39")	9.5 (.37")	5.5 (.21")	36.1 (1.41")	35.6 (1.39")	32 (1.25")	1.0 (.04")	1.8 (.07")
413-1	VG 95343 T08 E 005 A	38.6 (1.51")	19.0 (.74")	19.0 (.74")	10.0 (.39")	74.9 (2.92")	75.0 (2.93")	65.3 (2.55")	1.0 (.04")	1.8 (.07")

Dimensions in mm, inches in brackets. Subject to technical changes.

Combinations "On request"					
Adhesive	Material				
	B7	G	J	H	L
WM250	•	•	•	•	-
W8	•	•	•	•	-
W24	•	•	•	•	•
W21	-	-	-	•	-
HMT200A	•	•	-	•	-
V9500	•	•	•	-	•
Without Adhesive	•	•	•	•	•

Standard Combinations	
Type	Article Number
403-1-G	404-03180
410-1-G	404-10003
411-1-G	404-11180
413-1-G	404-13180



### 4-Way Outlet Shapes, Breakout Boots

#### Helashrink 400 Series, in line, low voltage

- Easy, time-saving insulation of cable branch point where it splits into single wires
- Made of tough, cross-linked, Polyolefin
- Adhesive is applied to relieve mechanical tension in cable harnesses



400 series supplied / fully recovered.

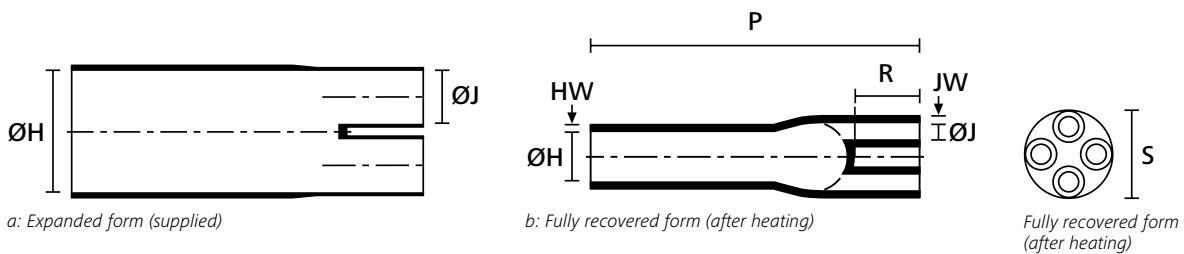

TYPE	ØH min. a	ØH max. b	ØJ min. a	ØJ max. b	P ± 10%	R ± 10%	HW ± 20%	JW ± 20%	S nom.
434-2	23.0 (.9")	11.0 (.43")	8.0 (.31")	2.8 (.11")	78.0 (3.04")	22.0 (.86")	1.6 (.06")	1.6 (.06")	18.0 (.7")
435-2	32.0 (1.25")	20.3 (.79")	13.0 (.51")	4.8 (.19")	93.5 (3.65")	28.5 (1.11")	2.9 (.11")	2.9 (.11")	27.0 (1.05")
437-1	60.0 (2.34")	25.4 (.99")	26.0 (1.01")	8.9 (.35")	240.0 (9.36")	48.0 (1.87")	4.5 (.18")	4.5 (.18")	43.0 (1.68")
438-2	68.0 (2.65")	35.6 (1.39")	31.0 (1.21")	13.5 (.53")	141.5 (5.52")	42.5 (1.66")	4.5 (.18")	4.5 (.18")	54.0 (2.11")

Dimensions in mm, inches in brackets. Subject to technical changes.

Combinations "On request"					
Adhesive	Material				
	B7	G	H	B8	J
W	•	•	•	•	•
W2	•	•	•	•	-
W24	•	•	•	-	•
V9500	•	•	-	-	•
HMT200A	•	•	-	•	•
W21	-	-	•	-	•
Without Adhesive	•	•	•	•	•

Standard Combinations	
Type	Article Number
435-2-J	404-35007
437-1-B7	404-37001
438-2-J	404-38008
434-2-G	404-34017





### 5-Way Outlet Shapes, Breakout Boots

#### Helashrink 500 Series, in line, low voltage

- Cable breakout boots for insulating and sealing cable crotch or conduit system
- Excellent resistance to abrasion and weathering



For Material / Adhesive selection and other information please refer to page 10.



500 Series supplied / fully recovered.

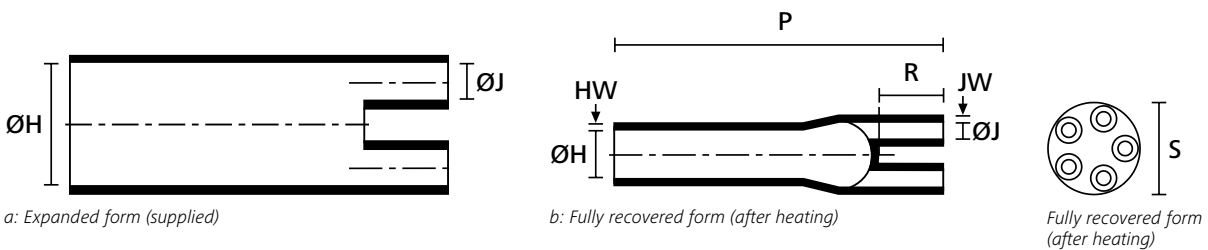

TYPE	ØH min. a	ØH max. b	ØJ min. a	ØJ max. b	P ± 10%	R ± 10%	HW ± 20%	JW ± 20%	S nom.
508-1	60.0 (2.36")	24.5 (.96")	30.0 (1.17")	7.5 (.29")	180.0 (7.02")	30.0 (1.17")	3.5 (.14")	3.0 (.12")	48.0 (1.87")

Dimensions in mm, inches in brackets. Subject to technical changes.

Combinations "On request"			
Adhesive	Material		
	B7	G	H
W	•	•	•
W2	•	•	-
V9500	•	•	-
HMT200A	•	•	•
W21	-	-	•
Without Adhesive	•	•	•

Standard Combinations	
Type	Article Number
508-1-B7	405-08021



### 6-Way Outlet Shapes, Breakout Boots

#### Helashrink 600 Series, in line, low voltage

- Cable breakout boots for insulating and sealing cable crotch or conduit system
- Excellent resistance to abrasion and weathering



600 Series supplied / fully recovered.

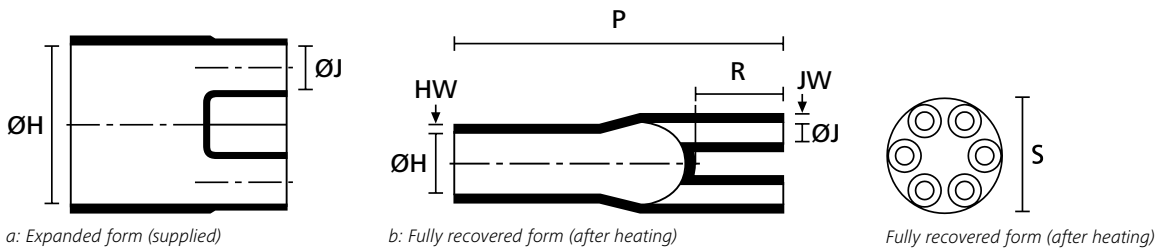

TYPE	ØH min. a	ØH max. b	ØJ min. a	ØJ max. b	P ± 10%	R ± 10%	HW ± 20%	JW ± 20%	S nom.
608-2	61.0 (2.38")	37.0 (1.44")	21.0 (.82")	9.0 (.35")	152.0 (5.93")	56.0 (2.18")	3.2 (.12")	3.2 (.12")	46 (1.79")
609-1	30.0 (1.17")	16.0 (.62")	8.2 (.32")	4.0 (.16")	75.0 (2.93")	20.0 (.78")	2.5 (.1")	1.5 (.06")	25.0 (.98")
609-2	40.0 (1.56")	16.0 (.62")	12.0 (.47")	4.0 (.16")	75.0 (2.93")	20.0 (.78")	2.5 (.1")	1.5 (.06")	25.0 (.98")

Dimensions in mm, inches in brackets. Subject to technical changes.

Combinations "On request"			
Adhesive	Material		
	B7	G	H
W	•	•	•
W2	•	•	-
V9500	•	•	-
HMT200A	•	•	•
W21	-	-	•
Without Adhesive	•	•	•

Standard Combinations	
Type	Article Number
608-2-B7	406-08023
609-1-G	406-09003
609-2-B7	406-09023



### Right-Angle Shapes, VG style

#### Helashrink 1100 Series, with rib

- Used in conjunction with a circular grooved adaptor
- Provides strain relief and an environmental seal



1152-4-G recovered onto a connector.



For Material / Adhesive selection and other information please refer to page 10.

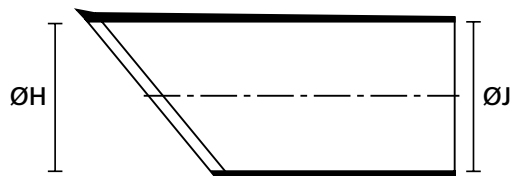

a: Expanded form (supplied)

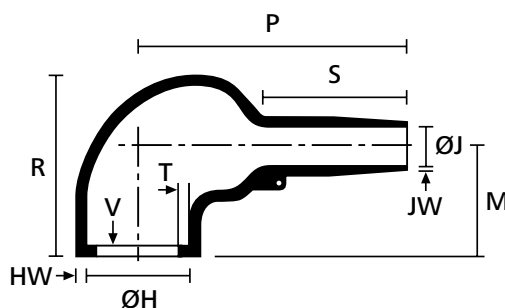

b: Fully recovered form (after heating)

TYPE	Designation as per AS/VG-Norm	ØH min. a	ØH max. b	ØJ min. a	ØJ max. b	P ± 10%	R ± 10%	HW ± 20%	JW ± 20%	V ± 10%	T ± 20%	M nom.	S nom.
1152-4	VG 95343 T06 E 001 A	24.0 (.94")	10.5 (.41")	24.0 (.94")	6.0 (.23")	26.0 (1.01")	25.0 (.98")	1.3 (.05")	0.5 (.02")	3.0 (.12")	1.0 (.04")	19.0 (.74")	10.0 (.39")
1154-4	VG 95343 T06 E 002 A	30.0 (1.17")	15.5 (.6")	30.0 (1.17")	6.0 (.23")	32.0 (1.25")	27.0 (1.05")	1.5 (.06")	0.8 (.03")	3.0 (.12")	1.0 (.04")	19.0 (.74")	12.0 (.47")
1155-4	VG 95343 T06 E 003 A	31.0 (1.21")	18.0 (.7")	31.0 (1.21")	7.0 (.27")	40.0 (1.56")	31.0 (1.21")	1.8 (.07")	1.0 (.04")	3.0 (.12")	1.0 (.04")	21.0 (.82")	15.0 (.59")
1156-4	VG 95343 T06 E 004 A	36.0 (1.4")	22.5 (.88")	36.0 (1.4")	8.5 (.33")	46.0 (1.79")	38.0 (1.48")	1.8 (.07")	1.0 (.04")	3.0 (.12")	1.0 (.04")	26.0 (1.01")	15.0 (.59")
1157-4	VG 95343 T06 E 005 A	43.0 (1.68")	28.5 (1.11")	43.0 (1.68")	10.0 (.39")	55.0 (2.15")	45.0 (1.76")	2.0 (.08")	1.0 (.04")	3.0 (.12")	1.7 (.07")	30.0 (1.17")	16.0 (.62")
1158-4	VG 95343 T06 E 006 A	60.0 (2.34")	35.0 (1.37")	60.0 (2.34")	16.0 (.62")	80.0 (3.12")	54.0 (2.11")	3.3 (.13")	1.5 (.06")	3.0 (.12")	1.7 (.07")	35.0 (1.37")	30.0 (1.17")
1159-4	VG 95343 T06 E 007 A	66.0 (2.57")	45.0 (1.76")	66.0 (2.57")	17.0 (.66")	108.0 (4.21")	68.0 (2.65")	3.8 (.15")	2.0 (.08")	3.0 (.12")	2.0 (.08")	42.0 (1.64")	51.0 (1.99")
1160-4	VG 95343 T06 E 008 A	82.0 (3.2")	61.0 (2.38")	82.0 (3.2")	25.0 (.98")	118.0 (4.6")	84.0 (3.28")	4.0 (.16")	4.0 (.16")	3.0 (.12")	2.0 (.08")	52.0 (2.03")	39.0 (1.52")

Dimensions in mm, inches in brackets. Subject to technical changes.

Combinations "On request"					
Adhesive	Material				
	B7	G	J	H	L
WM250	•	•	•	•	-
W8	•	•	•	•	-
W24	•	•	•	•	•
W21	-	-	•	•	-
HMT200A	•	•	•	•	-
V9500	•	•	•	-	-
Without Adhesive	•	•	•	•	•

Standard Combinations	
Type	Article Number
1152-4-G	411-52480
1154-4-G	411-54480
1155-4-G	411-55480
1156-4-G	411-56480
1157-4-G	411-57480
1158-4-G	411-58480
1159-4-G	411-59480
1160-4-G	411-60480



### Right-Angle Shapes, VG style

#### Helashrink 1100 Series, without rib, thick wall

- Provides connector cable strain relief
- Can be installed on the connector rear thread or plain shaft
- Allows easy re-entry for repair when combined with a hot melt adhesive



1114-1 supplied / fully recovered.

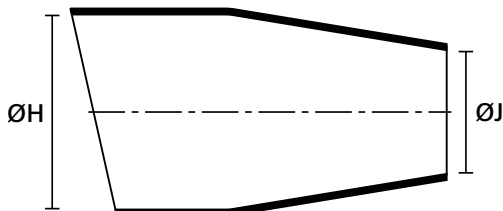

a: Expanded form (supplied)

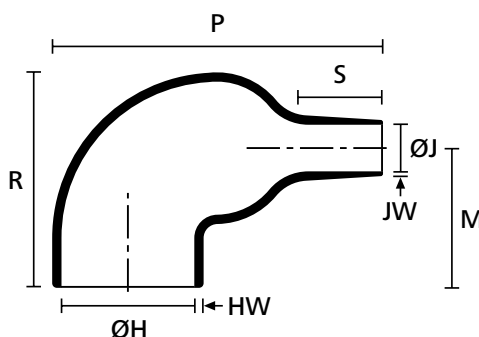

b: Fully recovered form (after heating)

TYPE	Designation as per AS/VG-Norm	ØH min. a	ØH max. b	ØJ min. a	ØJ max. b	P ± 20%	R ± 10%	HW ± 30%	JW ± 30%	M nom.	S nom.
1113-1	VG 95343 T06 J 003 A	19.0 (.74")	14.5 (.57")	8.0 (.31")	4.5 (.18")	39 (1.52")	26.0 (1.01")	2.5 (.1")	1.8 (.07")	19.0 (.74")	8.0 (.31")
1114-1	VG 95343 T06 J 004 A	23.5 (.92")	18.0 (.7")	11.5 (.45")	5.5 (.21")	51 (1.99")	33.0 (1.29")	3.0 (.12")	1.0 (.04")	22.0 (.86")	9.5 (.37")

Dimensions in mm, inches in brackets. Subject to technical changes.

Combinations "On request"				
Adhesive	Material			
	B7	G	J	H
WM250	•	•	•	•
W8	•	•	•	•
W24	•	•	•	•
W21	-	-	-	•
HMT200A	•	•	•	•
V9500	•	•	•	-
Without Adhesive	•	•	•	•

Standard Combinations	
Type	Article Number
1113-1-G	411-13002
1114-1-G	411-14004



### Right-Angle Shapes, MIL style

#### Helashrink 1100 Series, with rib

- Used in conjunction with a circular grooved adaptor for strain relief



For Material / Adhesive selection and other information please refer to page 10.



1108-4 supplied / fully recovered.

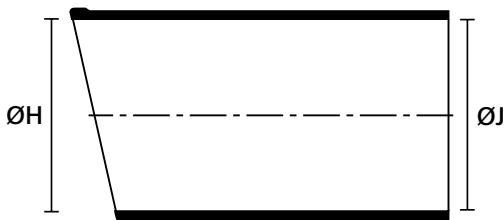

a: Expanded form (supplied)

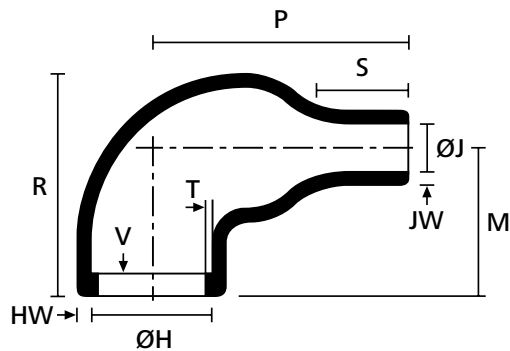

b: Fully recovered form (after heating)

TYPE	Designation as per AS/VG-Norm	ØH min. a	ØH max. b	ØJ min. a	ØJ max. b	P ± 10%	R ± 10%	HW ± 20%	M nom.	JW ± 30%	V max.	T ± 20%	S nom.
1101-4	AS85049/14105HU	42.6 (1.66")	27.9 (1.09")	42.6 (1.66")	9.7 (.38")	53.3 (2.08")	43.2 (1.68")	2.0 (.08")	27.9 (1.09")	2.0 (.08")	3.3 (.13")	1.7 (.07")	15.7 (.61")
1103-4	AS85049/14104HU	36.0 (1.4")	22.4 (.87")	36.0 (1.4")	8.4 (.33")	43.2 (1.68")	35.6 (1.39")	1.8 (.07")	22.9 (.89")	1.8 (.07")	3.3 (.13")	1.0 (.04")	12.7 (.5")
1104-4	AS85049/14103HU	30.9 (1.21")	17.8 (.69")	30.9 (1.21")	7.1 (.28")	35.6 (1.39")	30.5 (1.19")	1.8 (.07")	20.6 (.8")	1.8 (.07")	3.3 (.13")	1.0 (.04")	8.6 (.34")
1105-4	AS85049/14106HU	51.8 (2.02")	35.1 (1.37")	51.8 (2.02")	15.7 (.61")	78.7 (3.07")	53.3 (2.08")	3.3 (.13")	33 (1.29")	3.3 (.13")	3.3 (.13")	1.7 (.07")	30.5 (1.19")
1106-4	AS85049/14101HU	23.3 (.91")	10.4 (.41")	23.3 (.91")	5.6 (.22")	20.3 (.79")	22.9 (.89")	1.3 (.05")	15.2 (.59")	1.3 (.05")	3.3 (.13")	1.0 (.04")	5.8 (.23")
1107-4	AS85049/14102HU	28.4 (1.11")	14.2 (.55")	28.4 (1.11")	6.3 (.25")	29.8 (1.16")	28.5 (1.11")	1.5 (.06")	21.4 (.83")	1.5 (.06")	3.3 (.13")	1.0 (.04")	7.1 (.28")
1108-4		16.5 (.64")	7.9 (.31")	16.5 (.64")	2.5 (.1")	18.3 (.71")	20.1 (.78")	1.0 (.04")	15.2 (.59")	1.6 (.06")	3.3 (.13")	1.0 (.04")	5.1 (.2")
1109-4	AS85049/14107HU	66.0 (2.60")	44.5 (1.75")	66.0 (2.60")	20.3 (.80")	97.5 (3.84")	66.0 (2.60")	3.8 (.15")	-	3.8 (.15")	-	-	40.6 (1.60")
1181-4		12.0 (.47")	9.8 (.38")	6.0 (.23")	2.0 (.08")	19.0 (.74")	13.0 (.51")	1.0 (.04")	11.0 (.43")	0.5 (.02")	1.5 (.06")	0.6 (.02")	6.0 (.23")
1182-4		12.0 (.47")	7.6 (.3")	6.0 (.23")	2.0 (.08")	16.8 (.66")	13.0 (.51")	1.0 (.04")	-	0.5 (.02")	-	0.3 (.01")	6.0 (.23")

Dimensions in mm, inches in brackets. Subject to technical changes.



### Right-Angle Shapes, MIL style

Helashrink 1100 Series, with rib

Combinations "On request"					
Adhesive	Material				
	B7	G	J	H	L
WM250	•	•	•	•	-
W8	•	•	•	•	-
W24	•	•	•	•	•
HMT200A	•	•	•	•	-
V9500	•	•	•	-	-
Without Adhesive	•	•	•	•	•

Standard Combinations	
Type	Article Number
1101-4-G	411-01020
1103-4-G	411-03024
1104-4-G	411-04032
1105-4-J	411-05019
1106-4-G	411-06019
1107-4-G	411-07020
1108-4-B7	411-08015
1181-4-G	411-81480
1182-4-G	411-82001



### Right-Angle Shapes

#### Helashrink 1100 Series, without rib

- Strain relief for connector cable
- Can be installed on the connector rear thread or plain shaft
- Easy re-entry for repair when combined with hot melt adhesive



1108-1 supplied / fully recovered.



For Material / Adhesive selection and other information please refer to page 10.

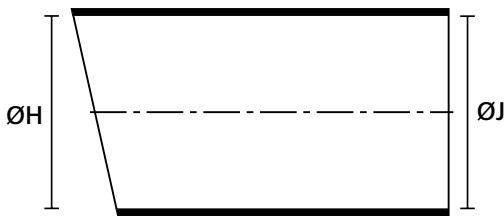

a: Expanded form (supplied)

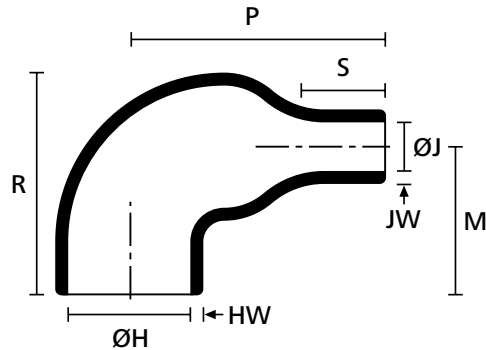

b: Fully recovered form (after heating)

TYPE	ØH min. a	ØH max. b	ØJ min. a	ØJ max. b	P ± 10%	R ± 10%	HW ± 20%	M nom.	JW ± 30%	S nom.
1100-4	26.0 (1.01")	15.5 (.6")	16.0 (.62")	4.0 (.16")	25.0 (.98")	17.0 (.66")	1.8 (.07")	17.0 (.66")	1.0 (.04")	20 (.78")
1101-1	43.1 (1.68")	27.9 (1.09")	43.1 (1.68")	9.7 (.38")	53.3 (2.08")	43.2 (1.68")	2.0 (.08")	27.9 (1.09")	2.0 (.08")	15.7 (.61")
1101-2	38.1 (1.49")	27.9 (1.09")	22.8 (.89")	9.7 (.38")	53.3 (2.08")	43.2 (1.68")	2.0 (.08")	27.9 (1.09")	2.0 (.08")	15.7 (.61")
1103-1	38.1 (1.49")	22.4 (.87")	38.1 (1.49")	8.4 (.33")	43.2 (1.68")	35.6 (1.39")	1.8 (.07")	22.9 (.89")	1.8 (.07")	12.7 (.5")
1103-2	30.4 (1.19")	22.4 (.87")	19.0 (.74")	8.4 (.33")	43.2 (1.68")	35.6 (1.39")	1.8 (.07")	22.9 (.89")	1.8 (.07")	12.7 (.5")
1104-1	24.1 (.94")	17.8 (.69")	15.7 (.61")	7.1 (.28")	35.6 (1.39")	30.5 (1.19")	1.8 (.07")	20.6 (.8")	1.8 (.07")	8.6 (.34")
1104-2	31.7 (1.24")	17.8 (.69")	31.7 (1.24")	7.1 (.28")	35.6 (1.39")	30.5 (1.19")	1.8 (.07")	20.6 (.8")	1.8 (.07")	8.6 (.34")
1105-1	52.3 (2.04")	35.1 (1.37")	52.3 (2.04")	15.7 (.61")	78.7 (3.07")	53.5 (2.09")	3.3 (.13")	33 (1.29")	3.3 (.13")	30.5 (1.19")
1105-2	46.9 (1.83")	35.1 (1.37")	35.3 (1.38")	15.7 (.61")	78.7 (3.07")	53.5 (2.09")	3.3 (.13")	33 (1.29")	3.3 (.13")	30.5 (1.19")
1106-1	23.6 (.92")	10.4 (.41")	23.6 (.92")	5.6 (.22")	20.3 (.79")	22.9 (.89")	1.3 (.05")	15.2 (.59")	1.3 (.05")	5.8 (.23")
1106-2	13.7 (.53")	10.4 (.41")	11.6 (.45")	5.6 (.22")	20.3 (.79")	22.9 (.89")	1.3 (.05")	15.2 (.59")	1.3 (.05")	5.8 (.23")
1107-1	28.4 (1.11")	14.2 (.55")	28.4 (1.11")	6.3 (.25")	29.8 (1.16")	28.5 (1.11")	1.5 (.06")	18.5 (.72")	1.5 (.06")	7.1 (.28")
1107-2	19.3 (.75")	14.2 (.55")	14.2 (.55")	6.3 (.25")	29.8 (1.16")	28.5 (1.11")	1.5 (.06")	18.5 (.72")	1.5 (.06")	7.1 (.28")

Dimensions in mm, inches in brackets. Subject to technical changes.





#### Right-Angle Shapes

Helashrink 1100 Series, without rib

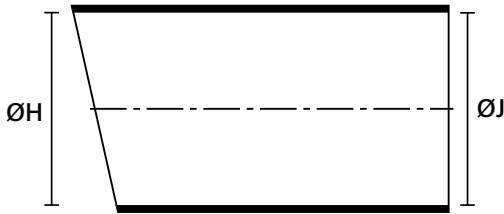

a: Expanded form (supplied)

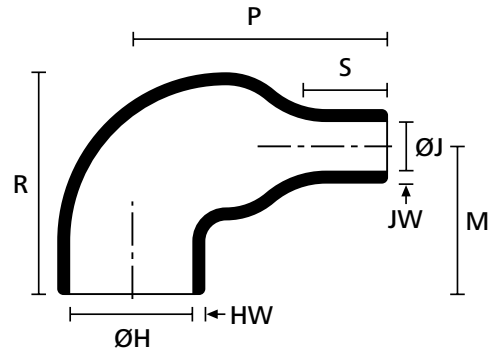

b: Fully recovered form (after heating)

TYPE	ØH min. a	ØH max. b	ØJ min. a	ØJ max. b	P ± 10%	R ± 10%	HW ± 20%	M nom.	JW ± 30%	S nom.
1108-1	16.5 (.64")	7.9 (.31")	16.5 (.64")	2.5 (.1")	18.3 (.71")	20.1 (.78")	1.0 (.04")	15.2 (.59")	1.6 (.06")	5.1 (.2")
1108-2	10.6 (.41")	7.9 (.31")	8.3 (.32")	2.5 (.1")	18.3 (.71")	20.1 (.78")	1.0 (.04")	15.2 (.59")	1.6 (.06")	5.1 (.2")
1109-1	66.0 (2.57")	44.5 (1.74")	66.0 (2.57")	20.3 (.79")	97.5 (3.8")	66.0 (2.57")	3.8 (.15")	41.7 (1.63")	3.8 (.15")	40.6 (1.58")

Dimensions in mm, inches in brackets. Subject to technical changes.

Combinations "On request"					
Adhesive	Material				
	B7	G	J	H	L
WM250	•	•	•	•	-
W8	•	•	•	•	-
W24	•	•	•	•	•
HMT200A	•	•	•	•	-
V9500	•	•	•	-	-
W21	-	-	-	•	-
Without Adhesive	•	•	•	•	•

Standard Combinations	
Type	Article Number
1100-4-G	411-00001
1101-1-GW8	411-01029
1101-2-G	411-01058
1103-1-G	411-03003
1103-2-G	411-03012
1104-1-G	411-04005
1104-2-G	411-04013
1105-1-G	411-05005
1105-2-G	411-05010
1106-1-G	411-06003
1106-2-B7.	411-06051
1107-1-G	411-07004
1107-2-G	411-07011
1108-1-B7	411-08002
1108-2-G	411-08011
1109-1-G	411-09004



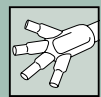

### Right-Angle Shapes, VG style/MIL style

#### Helashrink 1100 Series, with rib, low profile

- Lightweight, low profile, compact strain relief and mechanical protection
- Typically used on airborne harnesses



For Material / Adhesive selection and other information please refer to page 10.



1123-1-G supplied / fully recovered.

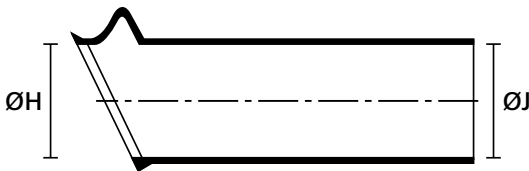

a: Expanded form (supplied)

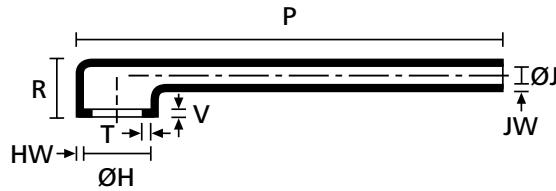

b: Fully recovered form (after heating)

TYPE	Designation as per AS/VG-Norm	ØH min. a	ØH max. b	ØJ min. a	ØJ max. b	P ± 10%	R ± 10%	HW ± 20%	T ± 10%	JW ± 30%	V ± 10%
1121-1	VG 95343 T06 F 001 A	22.0 (.86")	12.0 (.47")	22.0 (.86")	6.5 (.25")	70.0 (2.73")	19.0 (.74")	1.5 (.06")	1.0 (.04")	1.1 (.04")	3.0 (.12")
1121-4	AS85049/14109HU	22.3 (.87")	11.4 (.44")	22.3 (.87")	6.4 (.25")	105.2 (4.1")	18.5 (.72")	1.5 (.06")	1.0 (.04")	1.1 (.04")	3.3 (.13")
1122-1	VG 95343 T06 F 002 A	25.5 (.99")	15.0 (.59")	25.0 (.98")	7.5 (.29")	79.0 (3.08")	20.0 (.78")	1.5 (.06")	1.0 (.04")	1.1 (.04")	3.0 (.12")
1122-4	AS85049/14110HU	25.6 (1")	15.0 (.59")	25.6 (1")	7.5 (.29")	124.0 (4.84")	19.8 (.77")	1.5 (.06")	1.0 (.04")	1.1 (.04")	3.3 (.13")
1123-1	VG 95343 T06 F 003 A	29.0 (1.13")	19.0 (.74")	29.0 (1.13")	8.5 (.33")	89.0 (3.47")	21.0 (.82")	1.8 (.07")	1.0 (.04")	1.1 (.04")	3.0 (.12")
1123-4	AS85049/14111HU	29.4 (1.15")	19.0 (.74")	29.4 (1.15")	8.5 (.33")	146.3 (5.71")	20.8 (.81")	1.8 (.07")	1.0 (.04")	1.1 (.04")	3.3 (.13")
1124-1	VG 95343 T06 F 004 A	34.0 (1.33")	23.0 (.9")	34.0 (1.33")	10.0 (.39")	102.0 (3.98")	22.0 (.86")	1.8 (.07")	1.0 (.04")	1.1 (.04")	3.0 (.12")
1124-4	AS85049/14112HU	34.0 (1.33")	22.9 (.89")	34.0 (1.33")	10.0 (.39")	172.2 (6.72")	21.8 (.85")	1.8 (.07")	1.0 (.04")	1.1 (.04")	3.3 (.13")
1125-1	VG 95343 T06 F 005 A	37.0 (1.44")	30.0 (1.17")	37.0 (1.44")	11.0 (.43")	108.0 (4.21")	24.0 (.94")	2.0 (.08")	1.7 (.07")	1.1 (.04")	3.0 (.12")
1125-2		41.2 (1.61")	29.5 (1.15")	41.2 (1.61")	11.0 (.43")	82.0 (3.2")	24.4 (.95")	2.0 (.08")	1.7 (.07")	1.1 (.04")	3.3 (.13")
1125-4	AS85049/14113HU	29.5 (1.15")	37.3 (1.45")	37.3 (1.45")	11.0 (.43")	185.2 (7.22")	24.4 (.95")	2.0 (.08")	1.7 (.07")	1.1 (.04")	3.3 (.13")
1126-1	VG 95343 T06 F 006 A	43.5 (1.7")	34.0 (1.33")	43.5 (1.7")	12.0 (.47")	121.0 (4.72")	27.0 (1.05")	2.0 (.08")	1.7 (.07")	1.1 (.04")	3.0 (.12")
1126-4	AS85049/14114HU	43.7 (1.7")	34.0 (1.33")	43.7 (1.7")	12.0 (.47")	213.6 (8.33")	27.0 (1.05")	2.0 (.08")	1.7 (.07")	1.1 (.04")	3.3 (.13")
1127-1	VG 95343 T06 F 007 A	50.0 (1.95")	41.5 (1.62")	50.0 (1.95")	14.5 (.57")	132.0 (5.15")	30.0 (1.17")	2.3 (.09")	1.7 (.07")	1.4 (.05")	3.0 (.12")
1127-3		50.0 (1.95")	41.1 (1.6")	2.3 (.09")	14.5 (.57")	65.0 (2.54")	29.5 (1.15")	2.3 (.09")	1.7 (.07")	1.4 (.05")	3.3 (.13")
1127-4	AS85049/14115HU	50.0 (1.95")	41.1 (1.6")	2.3 (.09")	14.5 (.57")	224.5 (8.76")	9.5 (.37")	2.3 (.09")	1.7 (.07")	1.4 (.05")	3.3 (.13")

Dimensions in mm, inches in brackets. Subject to technical changes.





### Right-Angle Shapes, VG style/MIL style

Helashrink 1100 Series, with rib, low profile

TYPE	Designation as per AS/VG-Norm	ØH min. a	ØH max. b	ØJ min. a	ØJ max. b	P ± 10%	R ± 10%	HW ± 20%	T ± 10%	JW ± 30%	V ± 10%
1128-1	VG 95343 T06 F 008 A	62.5 (2.44")	47.0 (1.83")	62.5 (2.44")	18.0 (.7")	133.0 (5.19")	33.0 (1.29")	2.5 (.1")	2.0 (.08")	1.4 (.05")	3.0 (.12")
1128-4	AS85049/14116HU	62.7 (2.45")	47.0 (1.83")	62.7 (2.45")	18.0 (.7")	227.3 (8.86")	33.3 (1.3")	2.5 (.1")	2.0 (.08")	1.4 (.05")	3.3 (.13")
1129-1	VG 95343 T06 F 009 A	69.0 (2.69")	60.0 (2.34")	69.0 (2.69")	20.0 (.78")	137.0 (5.34")	35.0 (1.37")	2.5 (.1")	2.0 (.08")	1.4 (.05")	3.0 (.12")
1129-4	AS85049/14117HU	69.3 (2.7")	59.7 (2.33")	69.3 (2.7")	20.0 (.78")	233.4 (9.1")	35.1 (1.37")	2.5 (.1")	2.0 (.08")	1.4 (.05")	3.3 (.13")

Dimensions in mm, inches in brackets. Subject to technical changes.

Combinations "On request"					
Adhesive	Material				
	B7	G	J	H	L
WM250	•	•	•	•	-
W8	•	•	•	•	-
W24	•	•	•	•	•
HMT200A	•	•	•	•	-
V9500	•	•	•	-	-
W21	-	-	-	•	-
Without Adhesive	•	•	•	•	•

Standard Combinations	
Type	Article Number
1121-4-G	411-21007
1121-1-G	411-21180
1122-4-G	411-22015
1122-1-G	411-22180
1123-4-G	411-23013
1123-1-G	411-23180
1124-4-G	411-24009
1124-1-G	411-24180
1125-4-G	411-25008
1125-2-G	411-25027
1125-1-G	411-25180
1126-4-G	411-26008
1126-1-G	411-26180
1127-3-B7	411-27005
1127-4-G	411-27008
1127-1-G	411-27180
1128-4-G	411-28002
1128-1-G	411-28180
1129-1-G	411-29180
1129-4-J	411-29001



### Right-Angle Shapes, VG style

**Helashrink 1100 Series, with rib, low profile, high ratio**

- Use in applications of partially loaded connectors with small cable diameters
- Tail design for easy orientation prior to cooling
- Strain relief for connector cable

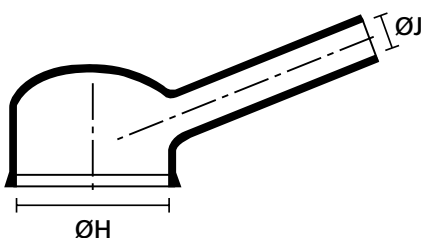

a: Expanded form (supplied)

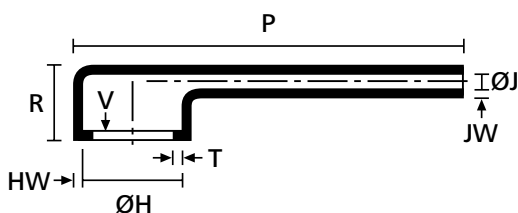

b: Fully recovered form (after heating)



1135-1-G supplied / fully recovered.



**For Material / Adhesive selection and other information please refer to page 10.**

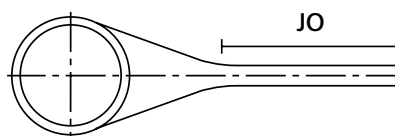

Fully recovered form (after heating)

TYPE	Designation as per AS/VG-Norm	ØH min. a	ØH max. b	ØJ min. a	ØJ max. b	P ± 10%	R ± 10%	HW ± 20%	JO ± 10%	JW ± 20%	V ± 10%	T ± 20%
1133-1	AS85049/14119HU	19.0	13.0	6.0	2.0	44.0	16.3	1.5	21.8	1.1	3.0	1.0
	VG 95343 T06 F 011 A	(.74")	(.51")	(.23")	(.08")	(1.72")	(.64")	(.06")	(.85")	(.04")	(.12")	(.04")
1133-2		19.0	13.0	6.0	2.0	30.0	16.0	1.5	1.0	1.1	3.3	1.0
		(.74")	(.51")	(.23")	(.08")	(1.17")	(.62")	(.06")	(.04")	(.04")	(.13")	(.04")
1134-1	AS85049/14120HU	26.0	19.0	7.5	2.5	67.0	18.0	1.8	29.2	1.1	3.0	1.0
	VG 95343 T18 H 001 A	(1.01")	(.74")	(.29")	(.1")	(2.61")	(.7")	(.07")	(1.14")	(.04")	(.12")	(.04")
1135-1	AS85049/14121HU	34.0	26.0	9.5	3.0	81.0	18.8	1.8	35.3	1.1	3.0	1.0
	VG 95343 T06 F 013 A	(1.33")	(1.01")	(.37")	(.12")	(3.16")	(.73")	(.07")	(1.38")	(.04")	(.12")	(.04")
1136-1	AS85049/14122HU	43.5	34.0	11.5	3.5	116.0	21.3	1.8	47.0	1.1	3.0	1.7
	VG 95343 T06 F 014 A	(1.7")	(1.33")	(.45")	(.14")	(4.52")	(.83")	(.07")	(1.83")	(.04")	(.12")	(.07")

Dimensions in mm, inches in brackets. Subject to technical changes.

Combinations "On request"					
Adhesive	Material				
	B7	G	J	H	L
WM250	•	•	•	•	-
W8	•	•	•	•	-
W24	•	•	•	•	•
HMT200A	•	•	•	•	-
V9500	•	•	•	-	-
W21	-	-	-	•	-
Without Adhesive	•	•	•	•	•

Standard Combinations	
Type	Article Number
1133-2-G	411-33011
1133-1-G	411-33180
1134-1-G	411-34180
1135-1-G	411-35180
1136-1-G	411-36180



#### T-Shapes, VG style/MIL style

##### Helashrink 1200 Series

- Strain relief, sealing and mechanical protection on cable harnesses



1202-1-G recovered onto a cable harness.

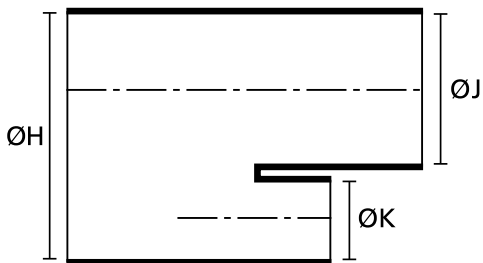

a: Expanded form (supplied)

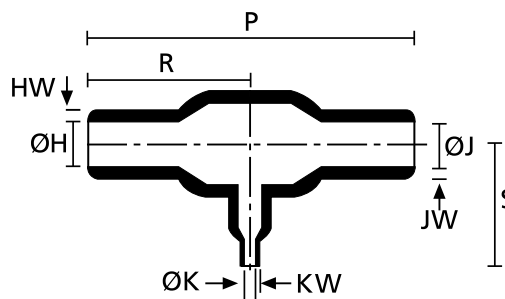

b: Fully recovered form (after heating)

TYPE	Designation as per AS/VG-Norm	ØH/J min. a	ØH/J max. b	ØK min. a	ØK max. b	P ± 10%	R ± 10%	HW ± 20%	S ± 10%	JW ± 20%	KW ± 20%
1201-1	VG 95343 T08 A 007 A	17.7 (.69")	8.9 (.35")	10.1 (.39")	5.1 (.2")	47.5 (1.85")	23.6 (.92")	1.5 (.06")	23.6 (.92")	1.5 (.06")	1.0 (.04")
1202-1	AS85049/14202HU	13.2 (.51")	6.1 (.24")	13.2 (.51")	6.1 (.24")	58.7 (2.29")	29.2 (1.14")	1.5 (.06")	29.2 (1.14")	1.5 (.06")	1.5 (.06")
	VG 95343 T08 A 010 A										
1203-1	VG 95343 T08 A 001 A	13.2 (.51")	6.0 (.23")	6.5 (.25")	3.0 (.12")	52.0 (2.03")	26.0 (1.01")	1.5 (.06")	19.3 (.75")	1.5 (.06")	1.0 (.04")
1205-1		17.7 (.69")	8.9 (.35")	7.6 (.3")	3.8 (.15")	50.8 (1.98")	25.4 (.99")	1.5 (.06")	25.4 (.99")	1.5 (.06")	1.0 (.04")
1206-1	AS85049/14201HU	6.6 (.26")	3.0 (.12")	6.6 (.26")	3.0 (.12")	29.7 (1.16")	14.7 (.57")	1.0 (.04")	14.7 (.57")	1.0 (.04")	1.0 (.04")
	VG 95343 T08 A 009 A										
1207-1	AS85049/14203HU	26.9 (1.05")	12.4 (.48")	26.9 (1.05")	12.4 (.48")	120.1 (4.68")	55.9 (2.18")	2.5 (.1")	59.9 (2.34")	2.5 (.1")	2.5 (.1")
	VG 95343 T08 A 011 A										
1209-1	VG 95343 T08 A 002 A	27 (1.05")	12.4 (.48")	13.2 (.51")	6.0 (.23")	108.0 (4.21")	54.0 (2.11")	2.5 (.1")	38.6 (1.51")	2.5 (.1")	1.5 (.06")

Dimensions in mm, inches in brackets. Subject to technical changes.

Combinations "On request"					
Adhesive	Material				
	B7	G	J	H	L
WM250	•	•	•	•	-
W8	•	•	•	•	-
W24	•	•	•	•	•
HMT200A	•	•	•	•	-
V9500	•	•	•	•	-
W21	-	-	-	•	-
Without Adhesive	•	•	•	•	•

Standard Combinations	
Type	Article Number
1201-1-G	412-01180
1202-1-G	412-02180
1203-1-G	412-03180
1205-1-G	412-05180
1206-1-G	412-06180
1207-1-G	412-07180
1209-1-G	412-09180



### T-Shapes

#### Helashrink 1200 Series, Offset

- This style provides strain relief, sealing and mechanical protection where a cable transition is required on the harness
- It is recommended that an adhesive be used if environmental sealing is required



**For Material / Adhesive selection and other information please refer to page 10.**



1217-1 supplied / fully recovered.

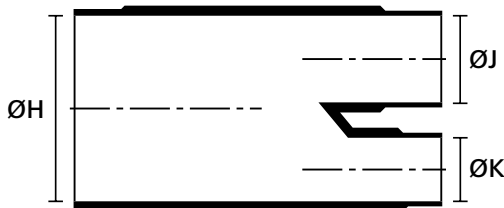

a: Expanded form (supplied)

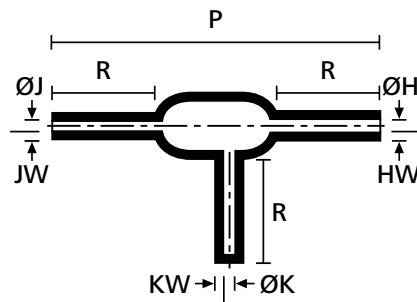

b: Fully recovered form (after heating)

TYPE	ØH min. a	ØH max. b	ØJ min. a	ØJ max. b	ØK min. a	ØK max. b	P ± 10%	R ± 10%	HW ± 20%	JW ± 20%	KW ± 20%
1217-1	10.0 (.39")	2.6 (.1")	6.0 (.23")	2.2 (.09")	6.0 (.23")	2.6 (.1")	57.0 (2.22")	19.0 (.74")	1.0 (.04")	1.0 (.04")	1.0 (.04")
1222-1	31.0 (1.21")	15.2 (.59")	18.0 (.7")	8.9 (.35")	25.0 (.98")	15.0 (.59")	92.0 (3.59")	52.0 (2.03")	2.3 (.09")	1.8 (.07")	2.3 (.09")
1223-1	29.5 (1.15")	16.3 (.64")	9.6 (.37")	5.3 (.21")	29.5 (1.15")	16.3 (.64")	93.2 (3.63")	56.6 (2.21")	2.5 (.1")	1.8 (.07")	2.5 (.1")

Dimensions in mm, inches in brackets. Subject to technical changes.

Combinations "On request"					
Adhesive	Material				
	B7	G	J	H	L
WM250	•	•	•	•	-
W8	•	•	•	•	-
W24	•	•	•	•	•
HMT200A	•	•	•	•	-
V9500	•	•	•	-	-
W21	-	-	-	•	-
Without Adhesive	•	•	•	•	•

Standard Combinations	
Type	Article Number
1217-1-G	412-17003
1222-1-G	412-22002
1223-1-G	412-23002



### T-Shapes, VG style

#### Helashrink 1200 Series, Offset

- For strain relief, sealing and mechanical protection
- Use adhesive for cable transition on harness, if environmental sealing is required



1204-1 supplied / fully recovered.

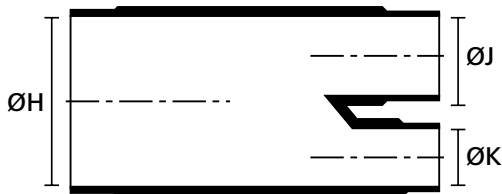

a: Expanded form (supplied)

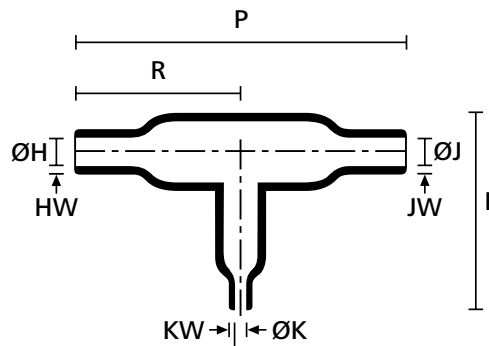

b: Fully recovered form (after heating)

TYPE	Designation as per AS/VG-Norm	ØH min. a	ØH max. b	ØJ min. a	ØJ max. b	ØK min. a	ØK max. b	P ± 10%	R ± 10%	HW ± 20%	KW ± 20%	S ± 10%	F ± 15%	JW ± 20%
1204-1	VG 95343 T08 A 016 A	13.0 (.51")	7.5 (.29")	6.5 (.25")	4.0 (.16")	6.5 (.25")	4.0 (.16")	56.0 (2.18")	33.0 (1.29")	1.5 (.06")	1.0 (.04")	-	27 (1.05")	1.0 (.04")
1216-1	VG 95343 T08 A 017 A	33.0 (1.29")	13.0 (.51")	16.5 (.64")	6.5 (.25")	16.5 (.64")	6.5 (.25")	97.0 (3.78")	54.0 (2.11")	2.5 (.1")	1.5 (.06")	38.5 (1.5")	-	1.5 (.06")
1226-1		30.5 (1.19")	15.2 (.59")	17.8 (.69")	8.9 (.35")	17.8 (.69")	8.9 (.35")	81.3 (3.17")	47.5 (1.85")	2.3 (.09")	1.3 (.05")	38.1 (1.49")	-	1.3 (.05")

Dimensions in mm, inches in brackets. Subject to technical changes.

Combinations "On request"					
Adhesive	Material				
	B7	G	J	H	L
WM250	•	•	•	•	-
W8	•	•	•	•	-
W24	•	•	•	•	•
HMT200A	•	•	•	•	-
V9500	•	•	•	-	-
W21	-	-	-	•	-
Without Adhesive	•	•	•	•	•

Standard Combinations	
Type	Article Number
1204-1-G	412-04180
1216-1-G	412-16180
1226-1-G	412-26002



### Angled T-Shapes, VG style

Helashrink 1300 Series, 30° & 45° angle

- Strain relief, sealing and mechanical protection on cable harnesses
- Branching part 30° & 45° Y-joint
- Mechanical strain relief for cable harnesses



**For Material / Adhesive selection and other information please refer to page 10.**



1303-1-G supplied / fully recovered.

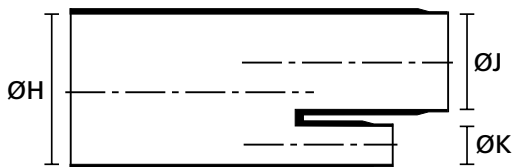

a: Expanded form (supplied)

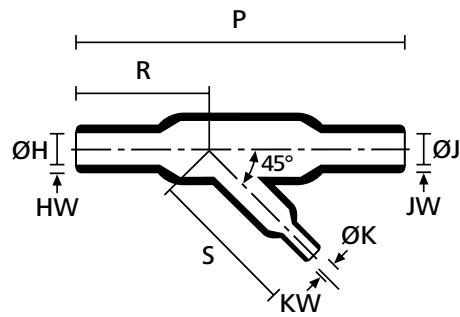

b: Fully recovered form (after heating)

TYPE	Angle	Designation as per AS/VG-Norm	ØH min. a	ØH max. b	ØJ min. a	ØJ max. b	ØK min. a	ØK max. b	P ± 10%	R ± 10%	KW ± 20%	S ± 10%	HW ± 30%	JW ± 30%
1301-1	45°	VG 95343 T08 B 001 A	13.0 (.51")	7.0 (.27")	13.0 (.51")	7.0 (.27")	7.0 (.27")	3.5 (.14")	50.0 (1.95")	23.0 (.9")	1.0 (.04")	23.0 (.9")	1.5 (.06")	1.5 (.06")
1302-1	45°	VG 95343 T08 B 004 A	27.0 (1.05")	13.0 (.51")	27.0 (1.05")	13.0 (.51")	7.0 (.27")	3.5 (.14")	93.0 (3.63")	41.0 (1.6")	1.0 (.04")	36.0 (1.4")	2.5 (.1")	2.5 (.1")
1303-1	45°	VG 95343 T08 B 002 A	27.0 (1.05")	14.0 (.55")	27.0 (1.05")	14.0 (.55")	13.0 (.51")	7.5 (.29")	145.0 (5.66")	70.0 (2.73")	1.5 (.06")	54.0 (2.11")	1.5 (.06")	1.5 (.06")
1306-1	45°	VG 95343 T06 B 010 A	13.0 (.51")	6.0 (.23")	6.5 (.25")	3.0 (.12")	6.5 (.25")	3.0 (.12")	45.0 (1.76")	23.0 (.9")	1.5 (.06")	21.5 (.84")	1.5 (.06")	1.0 (.04")
1307-1	45°	VG 95343 T19 B 011 A	27.0 (1.05")	12.5 (.49")	13.0 (.51")	6.0 (.23")	13.0 (.51")	6.0 (.23")	90.0 (3.51")	42.0 (1.64")	1.5 (.06")	43 (1.68")	2.5 (.1")	1.5 (.06")
1311-1	30°		30.4 (1.19")	15.0 (.59")	30.4 (1.19")	15.0 (.59")	20.3 (.79")	10.0 (.39")	82.6 (3.22")	32.0 (1.25")	1.8 (.07")	51 (1.99")	2.5 (.1")	2.5 (.1")

Dimensions in mm, inches in brackets. Subject to technical changes.

Combinations "On request"					
Adhesive	Material				
	B7	G	J	H	L
WM250	•	•	•	•	-
W8	•	•	•	•	-
W24	•	•	•	•	•
HMT200A	•	•	•	•	-
V9500	•	•	•	-	-
W21	•	•	•	•	-
Without Adhesive	•	•	•	•	•

Standard Combinations	
Type	Article Number
1301-1-G	413-01180
1302-1-G	413-02180
1303-1-G	413-03180
1306-1-G	413-06180
1307-1-GW24	413-07184
1311-1-G	413-11010



#### Double T-Shapes

##### Helashrink 1310 Series, 30° angle

- For cable harnesses needing specialised orientation
- Strain relief, sealing and mechanical protection



1310-1 supplied / fully recovered.

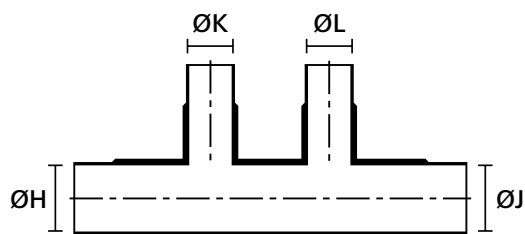

a: Expanded form (supplied)

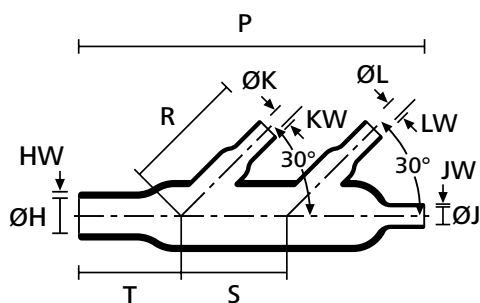

b: Fully recovered form (after heating)

TYPE	ØH min. a	ØH max. b	ØJ min. a	ØJ max. b	ØK min. a	ØK max. b	ØL min. a	ØL max. b	P ± 10%	R ± 10%	HW ± 20%	JW ± 20%	KW ± 20%	LW ± 20%	S ± 10%	T ± 10%
1310-1	30.4 (1.19")	15.2 (.59")	30.4 (1.19")	15.2 (.59")	12.7 (.5")	6.4 (.25")	12.7 (.5")	6.4 (.25")	88.9 (3.47")	50.8 (1.98")	2.5 (.1")	2.5 (.1")	1.3 (.05")	1.3 (.05")	25.4 (.99")	19.1 (.74")

Dimensions in mm, inches in brackets. Subject to technical changes.

Combinations "On request"					
Adhesive	Material				
	B7	G	J	H	L
WM250	•	•	•	•	-
W8	•	•	•	•	-
W24	•	•	•	•	•
HMT200A	•	•	•	•	-
V9500	•	•	•	-	-
Without Adhesive	•	•	•	•	•

Standard Combinations	
Type	Article Number
1310-1-G	413-10003





### Angle Elbow Shapes

#### Helashrink 1400 Series, 90° angle

- Provides strain relief and mechanical protection on cable orientations up to 90°
- Efficient design and numerous material/adhesive combinations provide quick and easy installation across a range of applications



1403-1 supplied / fully recovered.



**For Material / Adhesive selection and other information please refer to page 10.**

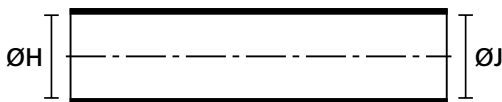

a: Expanded form (supplied)

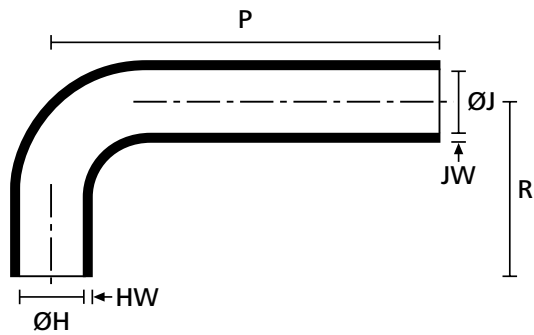

b: Fully recovered form (after heating)

TYPE	ØH min. a	ØH max. b	ØJ min. a	ØJ max. b	P ± 10%	R ± 10%	HW ± 20%	JW ± 20%
1401-1	31.7 (1.24")	15.7 (.61")	31.7 (1.24")	15.7 (.61")	88.9 (3.47")	50.8 (1.98")	2.3 (.09")	2.3 (.09")
1401-2	38.1 (1.49")	15.7 (.61")	38.1 (1.49")	15.7 (.61")	88.9 (3.47")	50.8 (1.98")	2.3 (.09")	2.3 (.09")
1403-1	15.7 (.61")	7.9 (.31")	15.7 (.61")	7.9 (.31")	44.5 (1.74")	25.4 (.99")	2.3 (.09")	2.3 (.09")
1405-1	25.0 (.98")	7.9 (.31")	25.0 (.98")	7.9 (.31")	30.0 (1.17")	15.0 (.59")	1.5 (.06")	1.5 (.06")
1406-1	20.0 (.78")	7.9 (.31")	20.0 (.78")	7.9 (.31")	45.0 (1.76")	15.0 (.59")	1.5 (.06")	1.5 (.06")
1408-2	19.0 (.74")	9.0 (.35")	19.0 (.74")	9.0 (.35")	44.5 (1.74")	44.5 (1.74")	1.8 (.07")	1.8 (.07")

Dimensions in mm, inches in brackets. Subject to technical changes.

Combinations "On request"					
Adhesive	Material				
	B7	G	J	H	L
WM250	•	•	•	•	-
W8	•	•	•	•	-
W24	•	•	•	•	•
HMT200A	•	•	•	•	-
V9500	•	•	•	-	-
W21	•	•	•	•	-
Without Adhesive	•	•	•	•	•

Standard Combinations	
Type	Article Number
1401-1-G	414-01003
1401-2-G	414-01006
1403-1-G	414-03002
1405-1-G	414-05003
1406-1-G	414-06003
1408-2-G	414-08004



#### Connector Cover for Min-D Series

Helashrink 1500 Series, with top entry

- Provides strain relief and mechanical protection for Min-D series connectors



For Material / Adhesive selection and other information please refer to page 10.



1505-1 supplied / fully recovered.

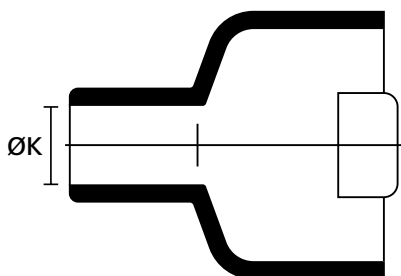

a: Expanded form (supplied)

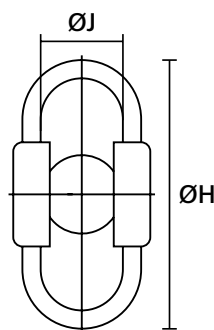

a: Expanded form (supplied)

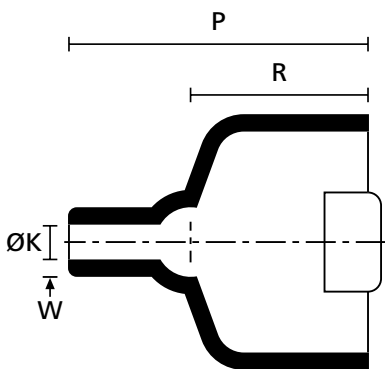

b: Fully recovered form (after heating)

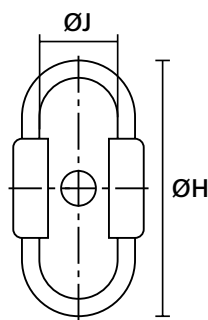

b: Fully recovered form (after heating)

TYPE	ØH min. a	ØH max. b	ØJ min. a	ØJ max. b	ØK min. a	ØK max. b	P ± 10%	R ± 10%	W ± 20%
1501-1	58.4 (2.28")	58.7 (2.29")	10.6 (.41")	10.7 (.42")	17.2 (.67")	8.6 (.34")	53.3 (2.08")	28.4 (1.11")	1.0 (.04")
1501-2	34.2 (1.33")	58.7 (2.29")	34.2 (1.33")	10.7 (.42")	34.2 (1.33")	8.6 (.34")	53.3 (2.08")	28.4 (1.11")	1.0 (.04")
1501-3	59.6 (2.32")	58.7 (2.29")	12.4 (.48")	10.7 (.42")	17.2 (.67")	8.6 (.34")	53.3 (2.08")	28.4 (1.11")	1.0 (.04")
1501-7	58.4 (2.28")	58.7 (2.29")	10.6 (.41")	10.7 (.42")	17.2 (.67")	8.6 (.34")	53.3 (2.08")	28.4 (1.11")	1.0 (.04")
1502-1	37.5 (1.46")	57.9 (2.26")	37.5 (1.46")	13.7 (.53")	37.5 (1.46")	10.4 (.41")	61.0 (2.38")	31.8 (1.24")	1.0 (.04")
1502-2	57.9 (2.26")	57.9 (2.26")	13.7 (.53")	3.7 (.14")	19.0 (.74")	10.4 (.41")	61.0 (2.38")	31.8 (1.24")	1.0 (.04")

Dimensions in mm, inches in brackets. Subject to technical changes.



### Connector Cover for Min-D Series

Helashrink 1500 Series, with top entry

TYPE	ØH min. a	ØH max. b	ØJ min. a	ØJ max. b	ØK min. a	ØK max. b	P ± 10%	R ± 10%	W ± 20%
1502-3	57.4 (2.24")	57.9 (2.26")	13.7 (.53")	13.7 (.53")	19.0 (.74")	10.4 (.41")	61.0 (2.38")	31.8 (1.24")	1.0 (.04")
1505-1	20.3 (.79")	20.3 (.79")	10.7 (.42")	10.7 (.42")	7.8 (.3")	4.1 (.16")	33.0 (1.29")	19.1 (.74")	1.0 (.04")
1505-2	16.0 (.62")	20.3 (.79")	16.0 (.62")	10.7 (.42")	16.0 (.62")	4.1 (.16")	33.0 (1.29")	19.1 (.74")	1.0 (.04")
1505-3	21.0 (.82")	20.3 (.79")	12.4 (.48")	10.7 (.42")	7.8 (.3")	4.1 (.16")	33.0 (1.29")	19.1 (.74")	1.0 (.04")
1505-7	20.3 (.79")	20.3 (.79")	15.0 (.59")	10.7 (.42")	2.0 (.08")	4.1 (.16")	48.0 (1.87")	19.1 (.74")	1.0 (.04")
1506-1	28.1 (1.1")	28.2 (1.1")	10.7 (.42")	10.7 (.42")	10.1 (.39")	5.3 (.21")	38.9 (1.52")	22.1 (.86")	1.0 (.04")
1506-2	19.0 (.74")	28.2 (1.1")	19.0 (.74")	10.7 (.42")	19.0 (.74")	5.3 (.21")	38.9 (1.52")	22.1 (.86")	1.0 (.04")
1507-1	42.1 (1.64")	42.2 (1.65")	10.7 (.42")	10.7 (.42")	13.9 (.54")	8.1 (.32")	45.0 (1.76")	25.4 (.99")	1.0 (.04")
1507-2	29.2 (1.14")	42.2 (1.65")	29.2 (1.14")	10.7 (.42")	29.2 (1.14")	8.1 (.32")	45.0 (1.76")	25.4 (.99")	1.0 (.04")
1507-3	42.1 (1.64")	42.2 (1.65")	10.7 (.42")	10.7 (.42")	13.9 (.54")	8.1 (.32")	45.0 (1.76")	25.4 (.99")	1.0 (.04")
1507-7	55.0 (2.15")	42.2 (1.65")	13.9 (.54")	10.7 (.42")	25.0 (.98")	8.1 (.32")	45.0 (1.76")	25.4 (.99")	1.0 (.04")

Dimensions in mm, inches in brackets. Subject to technical changes.

Combinations "On request"				
Adhesive	Material			
	B7	G	J	H
WM250	•	•	•	•
W8	•	•	•	•
W24	•	•	•	•
HMT200A	•	•	•	•
V9500	•	•	•	-
W21	-	-	-	•
Without Adhesive	•	•	•	•

Standard Combinations	
Type	Article Number
1501-1-B7	415-01001
1501-2-G	415-01010
1501-3-J	415-01016
1501-7-B7	415-01017
1502-1-J	415-02005
1502-2-G	415-02009
1502-3-J	415-02020
1505-1-G	415-05004
1505-2-B7	415-05011
1505-3-B7	415-05015
1505-7-J	415-05021
1506-1-G	415-06005
1506-2-B7	415-06012
1507-1-G	415-07005
1507-2-B7	415-07013
1507-3-G	415-07030
1507-7-G	415-07024



### GSR Graduated Strain Relief

#### Helashrink 1750 Series, with rib

- Features superior crush resistance and excellent strain relief



For Material / Adhesive selection and other information please refer to page 10.



1751-1 supplied / fully recovered.

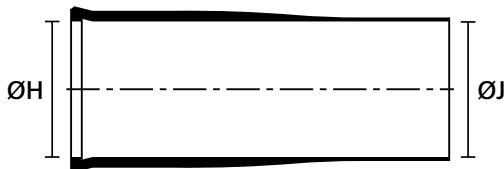

a: Expanded form (supplied)

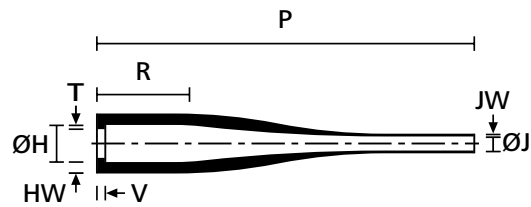

b: Fully recovered form (after heating)

TYPE	Designation as per AS/VG-Norm	ØH min. a	ØH max. b	ØJ min. a	ØJ max. b	P ± 10%	R ± 10%	HW ± 20%	JW ± 20%	V ± 10%	T ± 10%
1751-1	AS85049/14024HU	25.4 (.99")	16.5 (.64")	25.4 (.99")	8.3 (.32")	152.4 (5.94")	30.5 (1.19")	4.1 (.16")	1.5 (.06")	3.0 (.12")	1.5 (.06")
1751-2		33.0 (1.29")	16.5 (.64")	33.0 (1.29")	8.4 (.33")	153.0 (5.97")	30.5 (1.19")	4.1 (.16")	1.5 (.06")	3.0 (.12")	1.5 (.06")
1752-1	AS85049/14025HU	33.1 (1.29")	20.3 (.79")	33.1 (1.29")	10.9 (.43")	152.4 (5.94")	30.5 (1.19")	4.1 (.16")	1.5 (.06")	3.0 (.12")	1.5 (.06")
1752-2		43.2 (1.68")	20.3 (.79")	43.2 (1.68")	10.9 (.43")	153.0 (5.97")	30.5 (1.19")	4.1 (.16")	1.5 (.06")	3.0 (.12")	1.5 (.06")
1753-1	AS85049/14026HU	43.2 (1.68")	22.8 (.89")	43.2 (1.68")	14.2 (.55")	175.3 (6.84")	38.1 (1.49")	4.1 (.16")	2.0 (.08")	3.0 (.12")	1.5 (.06")
1753-2		53.3 (2.08")	22.9 (.89")	53.3 (2.08")	14.2 (.55")	175.3 (6.84")	38.0 (1.48")	4.1 (.16")	2.0 (.08")	3.0 (.12")	1.5 (.06")
1754-1	AS85049/14027HU	53.4 (2.08")	27.9 (1.09")	53.4 (2.08")	17.7 (.69")	175.3 (6.84")	38.1 (1.49")	4.1 (.16")	2.0 (.08")	3.0 (.12")	1.5 (.06")
1754-2		72.4 (2.82")	27.9 (1.09")	72.4 (2.82")	17.8 (.69")	175.3 (6.84")	38.0 (1.48")	4.1 (.16")	2.0 (.08")	3.0 (.12")	1.5 (.06")
1755-1	AS85049/14028HU	72.4 (2.82")	36.8 (1.44")	72.4 (2.82")	24.1 (.94")	182.9 (7.13")	40.6 (1.58")	4.1 (.16")	2.5 (.1")	3.0 (.12")	1.5 (.06")
1755-2		87.0 (3.39")	36.8 (1.44")	87.0 (3.39")	24.1 (.94")	184.0 (7.18")	41.0 (1.6")	4.1 (.16")	2.5 (.1")	3.0 (.12")	1.5 (.06")

Dimensions in mm, inches in brackets. Subject to technical changes.



**GSR Graduated Strain Relief**

Helashrink 1750 Series, with rib

Combinations "On request"				
Adhesive	Material			
	B7	G	J	H
WM250	.	.	.	.
W8	.	.	.	.
W24	.	.	.	.
HMT200A	.	.	.	.
V9500	.	.	.	-
W21	-	-	-	.
Without Adhesive	.	.	.	.

Standard Combinations	
Type	Article Number
1751-1-H	417-51001
1751-2-H	417-51009
1752-1-H	417-52001
1752-2-H	417-52005
1753-1-H	417-53001
1753-2-H	417-53005
1754-1-H	417-54001
1754-2-H	417-54005
1755-1-H	417-55001
1755-2-H	417-55005



#### Angle Shapes

**Helashrink 1800 Series, with rib, 30°, 45°, 60° angle**

- Provides strain relief and mechanical protection for harness systems
- Use in conjunction with a circular grooved adaptor



1821-42 supplied / fully recovered.



**For Material / Adhesive selection and other information please refer to page 10.**

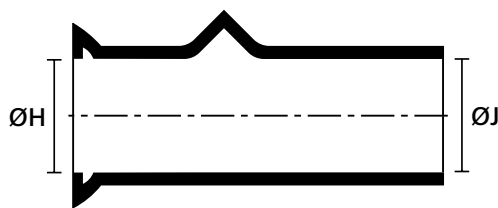

a: Expanded form (supplied)

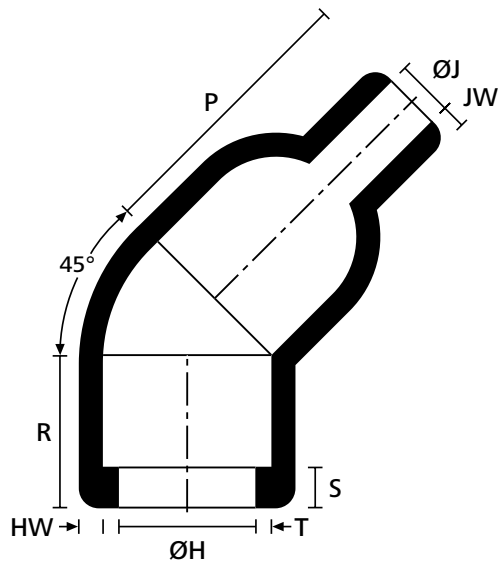

b: Fully recovered form (after heating)

TYPE	Angle	ØH min. a	ØH max. b	ØJ min. a	ØJ max. b	P ± 10%	R ± 10%	HW ± 20%	S ± 10%	JW ± 20%	T ± 10%
1803-4	45°	24.0 (.94")	17.8 (.69")	12.0 (.47")	5.6 (.22")	28.0 (1.09")	14.0 (.55")	2.8 (.11")	3.0 (.12")	2.3 (.09")	1.0 (.04")
1805-4	45°	40.0 (1.56")	18.8 (.73")	40.0 (1.56")	7.0 (.27")	28.0 (1.09")	11.0 (.43")	1.5 (.06")	3.0 (.12")	1.5 (.06")	1.0 (.04")
1806-4	45°	42.6 (1.66")	27.9 (1.09")	42.6 (1.66")	9.7 (.38")	85.0 (3.32")	17.8 (.69")	2.0 (.08")	3.0 (.12")	2.0 (.08")	1.7 (.07")
1807-4	45°	35.6 (1.39")	18.0 (.7")	35.6 (1.39")	7.4 (.29")	43.2 (1.68")	10.2 (.4")	1.8 (.07")	3.0 (.12")	1.8 (.07")	1.0 (.04")
1817-4	60°	60.0 (2.34")	33.7 (1.31")	60.0 (2.34")	14.8 (.58")	65.0 (2.54")	32.0 (1.25")	2.0 (.08")	32.0 (1.25")	1.0 (.04")	3.0 (.12")
1819-4	60°	43.0 (1.68")	28.2 (1.1")	43.0 (1.68")	9.9 (.39")	55.0 (2.15")	18.0 (.7")	2.0 (.08")	18.0 (.7")	1.0 (.04")	3.0 (.12")
1820-4	30°	36.0 (1.4")	21.4 (.83")	36.0 (1.4")	8.3 (.32")	46.0 (1.79")	26.0 (1.01")	1.8 (.07")	26.0 (1.01")	1.0 (.04")	8.6 (.34")
1821-42	45°	20.0 (.78")	14.2 (.55")	20.0 (.78")	4.1 (.16")	24.0 (.94")	10.0 (.39")	2.3 (.09")	3.0 (.12")	1.8 (.07")	1.1 (.04")
1830-4	45°	31.0 (1.22")	17.9 (.70")	31.0 (1.22")	7.0 (.28")	55.0 (2.15")	35.0 (1.38")	1.8 (.07")	-	1.8 (.07")	2.0 (.08")
1831-4	45°	36.0 (1.42")	22.1 (.87")	36.0 (1.42")	8.4 (.33")	60.0 (2.36")	40.0 (1.57")	2.0 (.08")	-	2.0 (.08")	2.0 (.08")
1832-4	45°	43.0 (1.69")	27.9 (1.10")	43.0 (1.69")	9.9 (.39")	65.0 (2.56")	45.0 (1.77")	2.2 (.09")	-	2.2 (.09")	2.0 (.08")

Dimensions in mm, inches in brackets. Subject to technical changes.



## Angle Shapes

Helashrink 1800 Series, with rib, 30°, 45°, 60° angle

Combinations "On request"					
Adhesive	Material				
	B7	G	J	H	L
WM250	•	•	•	•	-
W8	•	•	•	•	-
W24	•	•	•	•	•
HMT200A	•	•	•	-	-
V9500	•	•	•	•	-
W21	-	-	-	•	-
Without Adhesive	•	•	•	•	•

Standard Combinations	
Type	Article Number
1803-4-G	418-03005
1805-4-G	418-05003
1806-4-G	418-06002
1807-4-G	418-07003
1817-4-G	418-17001
1819-4-G	418-19001
1820-4-G	418-20001
1821-42-G	418-21013
1830-4-G	418-30003
1831-4-G	418-31001
1832-4-G	418-32000



#### Right Angle Cross Shapes

##### Helashrink 2000 Series

- The right-angle cross shape allows wires to be routed in four 90° directions
- Provides strain relief and mechanical protection



2003-1 supplied / fully recovered.

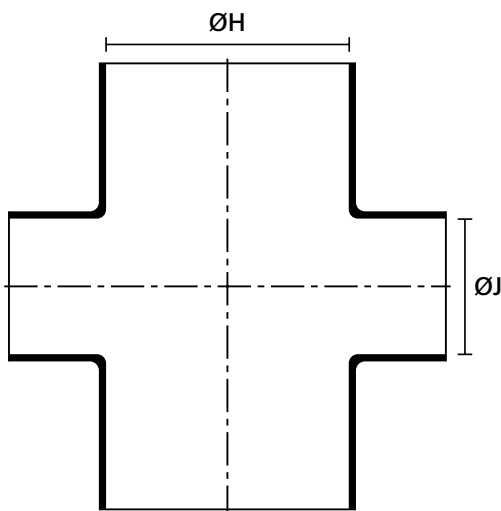

a: Expanded form (supplied)

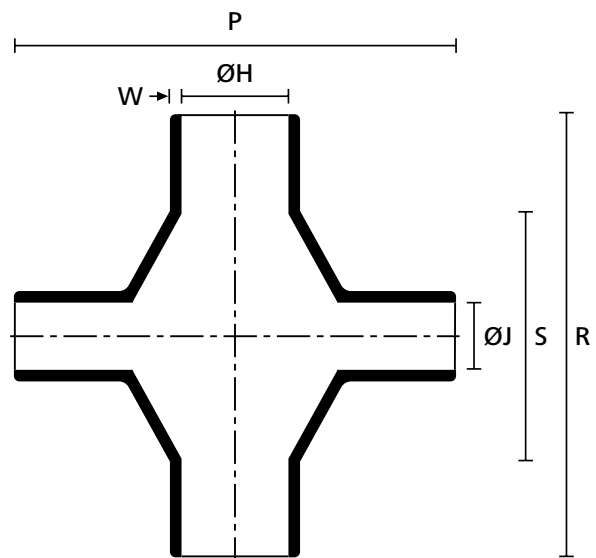

b: Fully recovered form (after heating)

TYPE	ØH min. a	ØH max. b	ØJ min. a	ØJ max. b	P ± 10%	R ± 10%	S ± 10%	W ± 20%
2003-1	19.3 (.75")	9.7 (.38")	13.2 (.52")	9.7 (.38")	38.1 (1.49")	38.1 (1.49")	22.1 (.86")	1.1 (.04")

Dimensions in mm, inches in brackets. Subject to technical changes.

Combinations "On request"				
Adhesive	Material			
	B7	G	J	H
WM250	•	•	•	•
W8	•	•	•	•
W24	•	•	•	•
HMT200A	•	•	•	•
V9500	•	•	•	-
W21	-	-	-	•
Without Adhesive	•	•	•	•

Standard Combinations	
Type	Article Number
2003-1-G	420-03002





### Locating Bushes

#### Helashrink 1760, 1790, 1820 Series

- Provides location, cushioning, shimming and protection on cable runs through bulk head or enclosure entry points
- Available in a range of materials and adhesives for most applications



For Material / Adhesive selection and other information please refer to page 10.



1793-1 supplied / fully recovered.

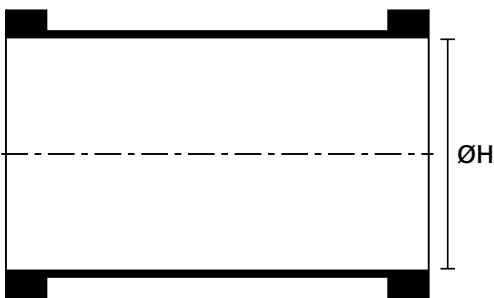

a: Expanded form (supplied)

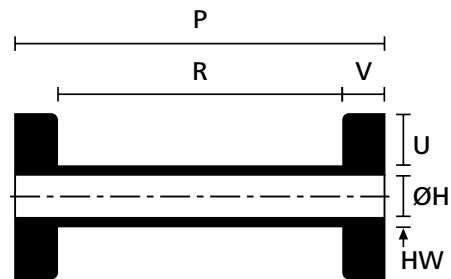

b: Fully recovered form (after heating)

TYPE	ØH min. a	ØH max. b	P ± 10%	R ± 10%	HW ± 20%	V ± 10%	U ± 20%
1793-1	20.0 (.78")	9.5 (.37")	35.0 (1.37")	25.0 (.98")	1.5 (.06")	5.0 (.2")	3.0 (.12")
1794-1	30.0 (1.17")	18.0 (.7")	35.0 (1.37")	25.0 (.98")	2.0 (.08")	5.0 (.2")	3.0 (.12")
1795-1	26.0 (1.01")	12.7 (.5")	35.0 (1.37")	25.0 (.98")	2.0 (.08")	5.0 (.2")	3.0 (.12")
1796-1	15.0 (.59")	6.4 (.25")	29.0 (1.13")	24.0 (.94")	1.5 (.06")	2.5 (.1")	2.0 (.08")
1822-1	12.0 (.47")	5.9 (.23")	30.0 (1.17")	24.0 (.94")	6.1 (.24")	3.0 (.12")	2.0 (.08")
1823-1	16.0 (.62")	7.8 (.3")	32.0 (1.25")	24.0 (.94")	6.2 (.24")	4.0 (.16")	2.0 (.08")

Dimensions in mm, inches in brackets. Subject to technical changes.

Combinations "On request"					
Adhesive	Material				
	B7	G	J	H	L
WM250	•	•	•	•	-
W8	•	•	•	•	-
W24	•	•	•	•	•
HMT200A	•	•	•	•	-
V9500	•	•	•	-	-
W21	-	-	-	•	-
Without Adhesive	•	•	•	•	•

Standard Combinations	
Type	Article Number
1793-1-G	417-93001
1794-1-L	417-94002
1795-1-G	417-95001
1796-1-G	417-96001
1822-1-G	418-22001
1823-1-G	418-23001



### Connector Cover for Min-D Series

Helashrink 2100 Series, with 90° entry

- Provides strain relief and mechanical protection for Min-D series connectors



**For Material / Adhesive selection and other information please refer to page 10.**



2101-1 supplied / fully recovered.

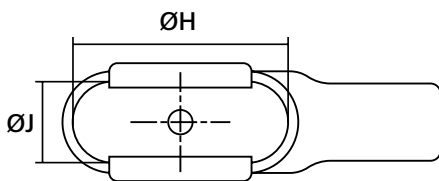

a: Expanded form (supplied)

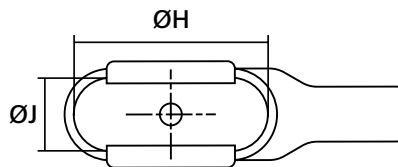

b: Fully recovered form (after heating)

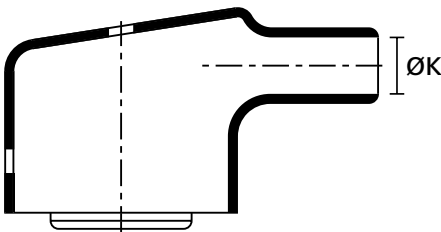

a: Expanded form (supplied)

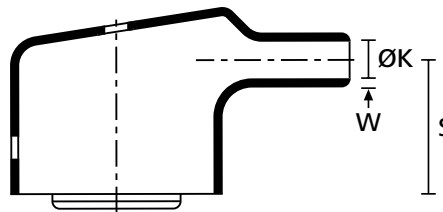

b: Fully recovered form (after heating)

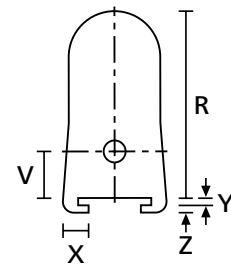

TYPE	ØH min. a	ØH max. b	ØJ min. a	ØJ max. b	ØK min. a	ØK max. b	R ± 10%	V ± 10%	W ± 20%	S ± 10%	X ± 10%	Y ± 10%	Z ± 10%
2101-1	20.3 (.79")	20.3 (.79")	10.7 (.42")	10.7 (.42")	7.8 (.3")	4.1 (.16")	21.6 (.84")	15.0 (.59")	1.0 (.04")	15.2 (.59")	3.0 (.12")	3.0 (.12")	1.1 (.04")
2101-2	16.0 (.62")	20.3 (.79")	10.0 (.39")	16.0 (.62")	16.0 (.62")	4.1 (.16")	21.6 (.84")	15.0 (.59")	1.0 (.04")	15.2 (.59")	3.0 (.12")	3.0 (.12")	1.1 (.04")
2102-1	28.1 (1.1")	28.2 (1.1")	10.6 (.41")	10.7 (.42")	10.1 (.39")	5.3 (.21")	24.6 (.96")	15.0 (.59")	1.0 (.04")	18.5 (.72")	3.0 (.12")	3.0 (.12")	1.1 (.04")
2102-2	19.0 (.74")	28.2 (1.1")	19.0 (.74")	10.7 (.42")	19.0 (.74")	5.3 (.21")	24.6 (.96")	15.0 (.59")	1.0 (.04")	18.5 (.72")	3.0 (.12")	3.0 (.12")	1.1 (.04")
2103-1	42.1 (1.64")	42.2 (1.65")	10.6 (.41")	10.7 (.42")	13.9 (.54")	7.4 (.29")	27.9 (1.09")	15.0 (.59")	1.1 (.04")	22.1 (.86")	3.0 (.12")	3.0 (.12")	1.1 (.04")
2103-2	29.2 (1.14")	42.2 (1.65")	29.2 (1.14")	10.7 (.42")	29.2 (1.14")	7.4 (.29")	27.9 (1.09")	15.0 (.59")	1.1 (.04")	22.1 (.86")	3.0 (.12")	3.0 (.12")	1.1 (.04")
2103-3*	42.9 (1.67")	42.2 (1.65")	12.4 (.48")	10.7 (.42")	13.9 (.54")	7.4 (.29")	27.9 (1.09")	15.0 (.59")	1.1 (.04")	22.1 (.86")	3.0 (.12")	1.1 (.04")	1.1 (.04")
2104-1	58.6 (2.29")	58.7 (2.29")	10.6 (.41")	10.7 (.42")	17.2 (.67")	8.6 (.34")	30.5 (1.19")	15.0 (.59")	1.0 (.04")	25.4 (.99")	3.0 (.12")	3.0 (.12")	1.1 (.04")
2105-1	57.9 (2.26")	57.9 (2.26")	13.7 (.53")	13.7 (.53")	19.0 (.74")	10.7 (.42")	32.3 (1.26")	15.0 (.59")	1.0 (.04")	25.4 (.99")	3.0 (.12")	1.1 (.04")	1.1 (.04")
2105-2	37.5 (1.46")	57.9 (2.26")	37.5 (1.46")	13.7 (.53")	37.5 (1.46")	10.7 (.42")	32.3 (1.26")	15.0 (.59")	1.0 (.04")	25.4 (.99")	3.0 (.12")	1.1 (.04")	1.1 (.04")

Dimensions in mm, inches in brackets. Subject to technical changes. \* This style is without lips.

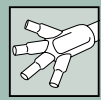

### Connector Cover for Min-D Series

Helashrink 2100 Series, with 90° entry

Combinations "On request"				
Adhesive	Material			
	B7	G	J	H
WM250	.	.	.	.
W8	.	.	.	.
W24	.	.	.	.
HMT200A	.	.	.	.
V9500	.	.	.	-
W21	-	-	-	.
Without Adhesive	.	.	.	.

Standard Combinations	
Type	Article Number
2101-1-G	421-01004
2101-2-G	421-01010
2102-1-G	421-02004
2102-2-B7	421-02009
2103-1-G	421-03004
2103-2-G	421-03014
2103-3-J	421-03019
2104-1-G	421-04005
2105-1-G	421-05003
2105-2-J	421-05010





### 3.1 Breakout Boots and End Caps

2-Way Outlet Shapes	Helashrink 200 Series, in line, low voltage	78
3-Way Outlet Shapes	Helashrink 300 Series, in line, low voltage	79
4-Way Outlet Shapes	Helashrink 400 Series, in line, low voltage	80
End Caps Low voltage	Helashrink 1600 Series	81
	Helashrink PEC Series, pinched	82



### 3.2 Constant Force Spring Adaptor

Zetalok		83
---------	--	----



### 3.3 Adhesives for Heat Shrinkable Moulded Shapes

Two-Component Adhesive	V9500	84
Hot Melt Tape	HMT200A	85
Hot Melt Adhesive Tape for Low Profile Products	TSA-200	86



### 2-Way Outlet Shapes, Breakout Boots

**Helashrink 200 Series, in line, low voltage**

#### Features and Benefits

- Easy, time-saving insulation of cable branch point where it splits into single wires
- Adhesive to relieve mechanical tension in cable harnesses



223-2 supplied / fully recovered.



**Cable breakouts are available for 2, 3, 4, 5 and 6 core cables.**

<b>MATERIAL</b>	Polyolefin, cross-linked (PO-X)
<b>Color</b>	Black (BK)
<b>Shrink Ratio</b>	up to 3:1
<b>Dielectric Strength</b>	15 kV/mm
<b>Operating Temperature</b>	-67°F to +212°F (-55°C to +100°C)
<b>Flammability</b>	ASTM D635

**RoHS** ✓

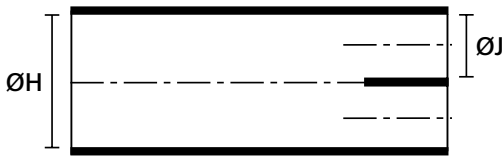

a: Expanded form (supplied)

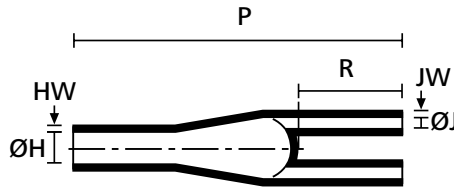

b: Fully recovered form (after heating)

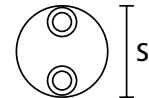

Fully recovered form (after heating)

TYPE	ØH min. a	ØH max. b	ØJ min. a	ØJ max. b	P ± 10%	R ± 10%	HW ± 20%	JW ± 20%	S nom.	Article No.
<b>223-2-B8W</b>	33.0 (1.29")	9.4 (.37")	17.5 (.68")	4.1 (.16")	94.0 (3.67")	30.0 (1.17")	1.5 (.06")	1.2 (.05")	20.0 (.78")	402-23058
<b>219-2-B8</b>	77.0 (3.00")	38.1 (1.49")	37.0 (1.44")	12.7 (.5")	141.5 (5.52")	42.5 (1.66")	3.8 (.15")	3.8 (.15")	44 (1.72")	402-19020
<b>219-2-B8W</b>	77.0 (3.00")	38.1 (1.49")	37.0 (1.46")	12.7 (.5")	141.5 (5.52")	42.5 (1.66")	3.8 (.15")	3.8 (.15")	44 (1.72")	402-19032

Dimensions in mm, inches in brackets. Subject to technical changes.



### 3-Way Outlet Shapes, Breakout Boots

Helashrink 300 Series, in line, low voltage

#### Features and Benefits

- Easy, time-saving insulation of cable branch point where it splits into single wires
- Adhesive is applied to relieve mechanical tension in cable harnesses



300 Series supplied / fully recovered.



Cable breakouts are available for 2, 3, 4, 5 and 6 core cables.

<b>Color</b>	Black (BK)
<b>Shrink Ratio</b>	up to 3:1
<b>Dielectric Strength</b>	15 kV/mm
<b>Operating Temperature</b>	-67°F to +212°F (-55°C to +100°C)
<b>Flammability</b>	ASTM D635

RoHS

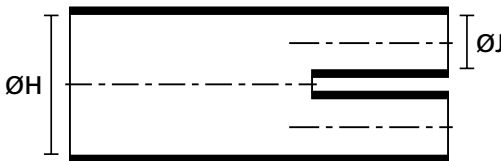

a: Expanded form (supplied)

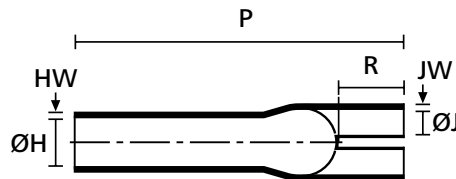

b: Fully recovered form (after heating)



Fully recovered form (after heating)

TYPE	ØH min. a	ØH max. b	ØJ min. a	ØJ max. b	P ± 10%	R ± 10%	HW ± 20%	JW ± 20%	S nom.	Article No.
354-1-B8W	45.0 (1.76")	10.0 (.39")	16.0 (.62")	4.0 (.16")	100.0 (3.9")	25.0 (.98")	3.0 (.12")	2.0 (.08")	-	403-54004
320-1-B8W	55.8 (2.18")	22.5 (.88")	30.4 (1.19")	9.0 (.35")	180.0 (7.02")	44.0 (1.72")	3.0 (.12")	2.0 (.08")	37.0 (1.44")	403-20012
355-1-B8W	100.0 (3.9")	28.0 (1.09")	40.0 (1.56")	13.0 (.51")	210.0 (8.19")	50.0 (1.95")	3.5 (.14")	2.5 (.1")	-	403-55005
342-1-B8W2	110.0 (4.29")	35.0 (1.37")	40.0 (1.56")	17.5 (.68")	230.0 (8.97")	45.0 (1.76")	4.0 (.16")	3.5 (.14")	65.0 (2.54")	403-42006
341-1-B8W2	125.0 (4.88")	59.0 (2.3")	50.8 (1.98")	25.4 (.99")	283.0 (11.04")	71.0 (2.77")	3.8 (.15")	3.8 (.15")	75.0 (2.93")	403-41005

Dimensions in mm, inches in brackets. Subject to technical changes.



Please note! Not all products listed on this page may have this approval.



### 4-Way Outlet Shapes, Breakout Boots

**Helashrink 400 Series, in line, low voltage**

#### Features and Benefits

- Easy, time-saving insulation of cable branch point where it splits into single wires
- Made of tough, cross-linked, Polyolefin
- Adhesive is applied to relieve mechanical tension in cable harnesses



400 series supplied / fully recovered.



**Cable breakouts are available for 2, 3, 4, 5 and 6 core cables.**

<b>Color</b>	Black (BK)
<b>Shrink Ratio</b>	up to 3:1
<b>Dielectric Strength</b>	15 kV/mm
<b>Operating Temperature</b>	-67°F to +212°F (-55°C to +100°C)
<b>Flammability</b>	ASTM D635

**RoHS** ✓

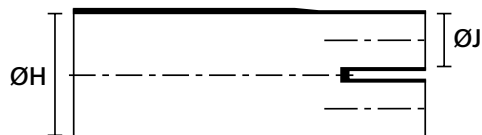

a: Expanded form (supplied)

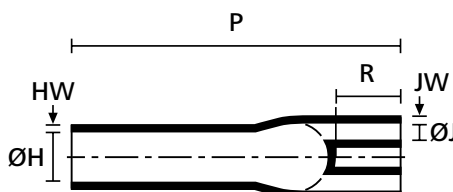

b: Fully recovered form (after heating)



Fully recovered form (after heating)

TYPE	ØH min. a	ØH max. b	ØJ min. a	ØJ max. b	P ± 10%	R ± 10%	HW ± 20%	JW ± 20%	S nom.	Article No.
442-1-B8W	28.0 (1.09")	9.0 (.35")	9.0 (.35")	1.8 (.07")	78.0 (3.04")	17.0 (.66")	2.7 (.11")	2.0 (.08")	20.0 (.78")	404-42022
408-2-B8W2	35.0 (1.37")	12.0 (.47")	15.0 (.59")	3.0 (.12")	95.0 (3.71")	24.0 (.94")	2.5 (.1")	2.0 (.08")	22.0 (.86")	404-08022
443-1-B8	35.0 (1.37")	12.0 (.47")	15.0 (.59")	3.0 (.12")	132.0 (5.15")	26.0 (1.01")	3.0 (.12")	2.5 (.1")	22.0 (.86")	404-43002
409-2-B8W2	47.4 (1.85")	22.9 (.89")	21.5 (.84")	6.4 (.25")	165.0 (6.44")	38.1 (1.49")	4.1 (.16")	3.3 (.13")	38.1 (1.49")	404-09021
418-4-B8W2	60.0 (2.34")	22.9 (.89")	30.0 (1.17")	6.4 (.25")	202.0 (7.88")	38.1 (1.49")	4.1 (.16")	3.3 (.13")	38.1 (1.49")	404-18020
444-2-B8W2	95.0 (3.71")	35.6 (1.39")	35.6 (1.39")	12.5 (.49")	240.0 (9.36")	55.0 (2.15")	4.0 (.16")	3.5 (.14")	50.8 (1.98")	404-44022

Dimensions in mm, inches in brackets. Subject to technical changes.





### End Caps

#### Helashrink 1600 Series, low voltage

End caps are suitable for use on both polymeric and paper insulated, lead jacketed cables which may include aluminium or steel armouring.

#### Features and Benefits

- Seal cables during storage or transportation
- Insulating cap for live LV cables (0.6/1kV)
- Adhesive lining for excellent environmental seal
- High shrink ratio to minimise number of sizes needed
- Outer end seal marked with lightning flashes to indicate live circuit
- Can be fitted with air valves for pressurised cable applications
- High shrink ratio to minimise number of sizes needed



The appropriate end cap for every cable diameter, and cable types.



For Material / Adhesive information please refer to page 14.

<b>MATERIAL</b>	Polyolefin, cross-linked (PO-X)
<b>Color</b>	Black (BK)
<b>Shrink Ratio</b>	up to 3:1
<b>Min. Shrink Temperature</b>	+275 °F (+135 °C)
<b>Operating Temperature</b>	-67°F to +176°F (-55°C to +80°C)
<b>Dielectric Strength</b>	15 kV/mm
<b>Flammability</b>	ASTM D635

RoHS



a: Expanded form (supplied)

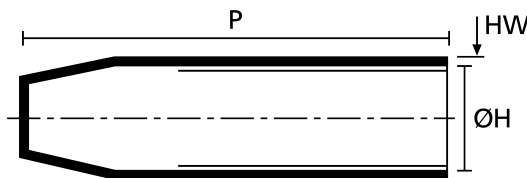

b: Fully recovered form (after heating)

TYPE	Bundle Ø min.	Bundle Ø max.	ØH min. a	ØH max. b	P ± 10%	HW ± 20%	Article No.
1612-1-B5W2	4.0 (.16")	8.0 (.31")	12.0 (.47")	4.0 (.16")	40.0 (1.57")	2.6 (.1")	416-12046
1613-1-B5W2	6.5 (.26")	16.0 (.63")	20.0 (.79")	6.0 (.24")	55.0 (2.17")	2.8 (.11")	416-13054
1601-1-B8W	10.0 (.39")	19.0 (.75")	25.0 (.98")	8.5 (.33")	65.0 (2.56")	2.8 (.11")	416-01013
1620-1-B5W2	13.0 (.51")	28.0 (1.10")	35.0 (1.37")	12.7 (.5")	184.0 (7.18")	3.3 (.13")	416-20028
1614-1-B5W2	16.0 (.63")	32.0 (1.26")	40.0 (1.57")	15.0 (.59")	75.0 (2.95")	3.3 (.13")	416-14047
1615-1-B5W2	26.0 (1.02")	51.0 (2.01")	62.0 (2.44")	23.0 (.90")	132.0 (5.20")	3.8 (.15")	416-15035
1617-1-B5W2	32.0 (1.26")	61.0 (2.4")	75.0 (2.95")	32.0 (1.26")	140.0 (5.51")	4.0 (.16")	416-17033
1616-1-B5W2	48.0 (1.89")	80.0 (3.15")	105.0 (4.13")	45.0 (1.77")	135.0 (5.31")	4.0 (.16")	416-16053
1609-1-B5W2	65.0 (2.56")	110.0 (4.33")	60.0 (2.36")	120.0 (4.72")	150.0 (5.90")	4.2 (.17")	416-09000
1610-1-B5W2	90.0 (3.54")	135.0 (5.31")	160.0 (6.30")	82.0 (3.23")	135.0 (5.31")	4.5 (.18")	416-10000

Dimensions in mm, inches in brackets. Subject to technical changes.



### Pinched End Caps

#### Helashrink PEC Series, low voltage

Pinched End Caps can be used for mechanical and environmental protection of stub splices in electrical harnesses. Due to the fast and easy installation, these caps can be used for non-electrical applications as well.

#### Features and Benefits

- Small size End Caps
- Fast and easy application
- With Inner adhesive layer for moisture sealing
- 3:1 shrink ratio
- Different diameters for wide application range
- Other lengths available on request



The appropriate end cap for every cable diameter, and cable types.

<b>MATERIAL</b>	Polyolefin, cross-linked (PO-X)
<b>Color</b>	Black (BK)
<b>Shrink Ratio</b>	3:1
<b>Min. Shrink Temperature</b>	+248 °F (+120 °C)
<b>Operating Temperature</b>	-49°F to +257°F (-45°C to +125°C)
<b>Dielectric Strength</b>	15 kV/mm according to IEC 684 P2
<b>Flammability</b>	self-extinguishing in 30 seconds according to SAE-AMS-DTL-23053/4

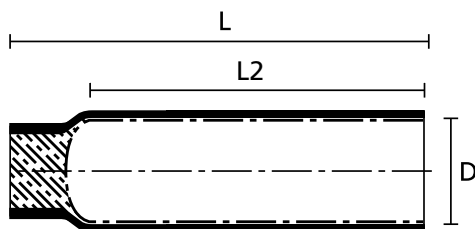

PEC-Series expanded.

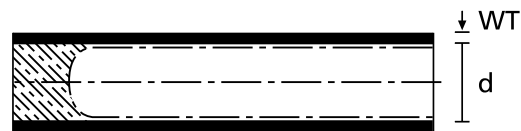

PEC-Series recovered.



TYPE	Supplied Ø (D)	Recovered Ø (D)	Wall Thickness (WT)	Length (L)	Length (L2)	Pkg. Qty.	Article No.
PEC-3/1	3.0 (.12")	1.0 (.04")	1.0 (.04")	25.0 (.98")	20.0 (.79")	50 Pieces	416-00000
PEC-4.8/1.5	4.8 (.19")	1.5 (.06")	1.0 (.04")	30.0 (1.18")	25.0 (.98")	50 Pieces	416-00003
PEC-6/2	6.0 (.24")	2.0 (.08")	1.0 (.04")	30.0 (1.19")	25.0 (.98")	50 Pieces	416-00001
PEC-9/3	9.0 (.35")	3.0 (.12")	1.4 (.06")	35.0 (1.38")	27.0 (1.06")	50 Pieces	416-00002

Dimensions in mm, inches in brackets. Subject to technical changes.



## Constant Force Spring Adaptor

### Zetalok

Predominantly used in the Aerospace, Defence and Professional Electronics sectors.

#### Features and Benefits

- Unique re-enterable termination system for connecting a cable shielding braid to a circular connector
- In conjunction with our Heatshrink moulded shape, a sealed environmental termination system is achieved
- The main feature is that the termination can be re-entered when required
- Possible to effect repairs to connector pins/sockets without the need to discard any part of the shielding system
- Due to the self-tensioning nature of the spring, it provides excellent resistance to vibration and shock



Zetalok installation system.

<b>MATERIAL</b>	Stainless Steel (SS)	
<b>Color</b>	Metal (ML)	Silver (SR)

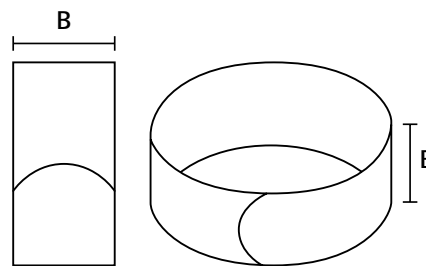
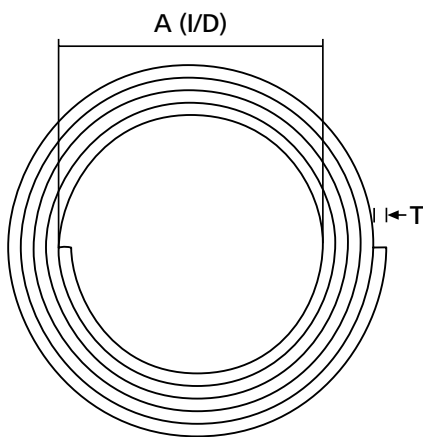

TYPE	Inside Ø (A)	Material Width (B)	Length (L)	Thickness (T)	Article No.
HE-050-2	7.14 (.28")	6.53 (.26")	108.0 (4.25")	0.1016 (.004")	425-00003
HE-050	7.34 (.29")	9.53 (.38")	107.9 (4.25")	0.1016 (.004")	425-00002
HE-100-1	9.10 (.36")	9.53 (.38")	119.0 (4.69")	0.1016 (.004")	425-00004
HE-200-2	14.40 (.57")	9.53 (.38")	127.0 (5")	0.1775 (.007")	425-00005
HE-300-3	18.51 (.73")	6.35 (.25")	232.0 (9.13")	0.2540 (.01")	425-00007
HE-300-4	18.64 (.73")	9.53 (.38")	260.3 (10.25")	0.2540 (.01")	425-00008
HE-400-4	24.86 (.98")	9.53 (.38")	217.5 (8.56")	0.3048 (.012")	425-00009

Dimensions in mm, inches in brackets. Subject to technical changes.



## Two-Component Adhesive for Heat Shrinkable Tubing and Shapes

**V9500**

### Features and Benefits

- High performance, two-part epoxy adhesive
- Very resistant to most solvents and fuels, even at elevated temperatures
- Two different packages available
- V9500 available in 10g sachets for manual mixing
- Processing set: emery paper, small mixing bowl and wooden spatula
- High performance bonding
- Meets military requirements for heat shrinkable components for harnesses
- VG-approved



Two-component epoxy adhesive V9500.



The V9500 applicator gun guarantees the clean and precise coating of special fittings.

<b>MATERIAL</b>	Epoxy resins (EP)
<b>Color</b>	Black (BK)
<b>Curing Temperature</b>	+275°F (+135°C)
<b>Curing Time</b>	24 hours at +77°F (+25°C), 2 hours at +185°F (+85°C)
<b>Operating Temperature</b>	-103°F to +302°F (-75°C to +150°C)
<b>Specifications</b>	VG 95343



TYPE	Description	Designation as per AS/VG-Norm	Article No.
<b>V9500 Epoxy Kit</b>	5 x 10g sachets (50g), 5 x mixing pots, 5 x mixing sticks, 5 x emery papers	VG 95343 T15 A 001 A	627-95000
	1 x dual cartridge, 5 x mixing pots, 5 x mixing sticks, 5 x emery papers	VG 95343 T15 A 002 B	627-95001
<b>V9500 Epoxy Cartridge</b>	Two-component adhesive cartridge	VG 95343 T15 A	627-95002
<b>V9500 Applicator Gun</b>	Applicator gun	VG 95343 T15 DA	627-95003
<b>V9500 Applicator Nozzle</b>	Mixing nozzle	VG 95343 T15 MA	627-95004

Dimensions in mm, inches in brackets. Subject to technical changes.



Please note! Not all products listed on this page may have this approval.



## Hot Melt Tape for Heat Shrinkable Tubing and Shapes

### HMT200A

Designed for use with heat shrink sleeving and mouldings.

#### Features and Benefits

- Hot melt tape flows when heated to seal against moisture
- For heat shrink tubing and mouldings



HMT200A-Tape.



Adhesive tape HMT200A for sealing against humidity.

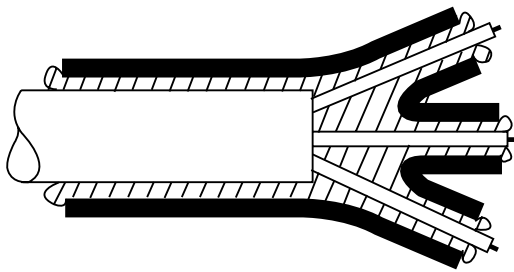

HMT200A

<b>MATERIAL</b>	Ethylenevinylacetate (EVA)
<b>Operating Temperature</b>	-67°F to +221°F (-55°C to +105°C)
<b>Specifications</b>	DEF STAN 59-97 Type W (W)



TYPE	Thickness (T)	Width (W)	Color	Reel Length	Article No.
HMT200A	0.25 (.0098")	25.0 (.98")	Translucent (TT)	10.0 m (32 ft)	354-02260
	0.25 (.0098")	25.0 (.98")	Translucent (TT)	50.0 m (164 ft)	354-02259

Dimensions in mm, inches in brackets. Subject to technical changes.



Please note! Not all products listed on this page may have this approval.



### High Temperature Hot Melt Adhesive Tape for Low Profile Products

#### TSA-200

Designed for use with our -9 and -8 heat shrink materials.

#### Features and Benefits

- A high temperature hot melt adhesive that bonds well to polyethylene and metals
- Compliments -9 and -8 material (SCX15112 and SCX15111) whilst having good resistance to water ingress
- The hotmelt tape flows when heated to provide a permanent environmental seal
- Store below 40°C and away from direct sunlight



Hot melt adhesive TSA-200.

<b>MATERIAL</b>	Thermoplastic Polyester Elastomer (TPC)
<b>Color</b>	Black (BK)
<b>Operating Temperature</b>	-67°F to +257°F (-55°C to +125°C)

**RoHS** ✓

TYPE	Thickness (T)	Width (W)	Reel Length	Article No.
TSA-200	0.6 (.024")	22.0 (.87")	25 m (83 ft)	354-03000

Dimensions in mm, inches in brackets. Subject to technical changes.



#### 4.1 HellermannTyton Product Standards

Standards for HellermannTyton Heat Shrinkable Moulded Shapes according to VG Norm	88
VG/MIL Specification Cross Reference	90
HellermannTyton Shapes for use with MIL Connectors	91
MIL Specification Slash Sheet Cross Reference	92
AS85049 Qualification	93



## Standards for HellermannTyton Heat Shrinkable Moulded Shapes according to VG Norm

Description VG-Norm	Description HellermannTyton
VG 95343 T06 A 001 A	152-41-G
VG 95343 T06 A 002 A	153-41-G
VG 95343 T06 A 003 A	154-41-G
VG 95343 T06 A 004 A	155-41-G
VG 95343 T06 A 005 A	156-41-G
VG 95343 T06 A 006 A	157-41-G
VG 95343 T06 A 007 A	158-41-G
VG 95343 T06 A 008 A	159-41-G
VG 95343 T06 A 009 A	160-41-G
VG 95343 T06 A 010 A	199-4-G
VG 95343 T06 B 001 A	152-42-G
VG 95343 T06 B 002 A	153-42-G
VG 95343 T06 B 003 A	154-42-G
VG 95343 T06 B 004 A	155-42-G
VG 95343 T06 B 005 A	156-42-G
VG 95343 T06 B 006 A	157-42-G
VG 95343 T06 B 007 A	158-42-G
VG 95343 T06 B 008 A	159-42-G
VG 95343 T06 B 009 A	160-42-G
VG 95343 T06 C 001 A	157-43-G
VG 95343 T06 C 002 A	158-43-G
VG 95343 T06 C 003 A	159-43-G
VG 95343 T06 C 004 A	160-43-G
VG 95343 T06 D 001 A	129-1-G
VG 95343 T06 D 002 A	130-1-G
VG 95343 T06 D 003 A	131-1-G
VG 95343 T06 D 004 A	132-1-G
VG 95343 T06 D 005 A	133-1-G
VG 95343 T06 D 006 A	134-1-G
VG 95343 T06 D 007 A	135-1-G
VG 95343 T06 D 008 A	136-1-G
VG 95343 T06 D 009 A	138-1-G
VG 95343 T06 D 011 A	176-1-G
VG 95343 T06 D 012 A	177-1-G
VG 95343 T06 D 013 A	178-1-G
VG 95343 T06 D 014 A	179-1-G
VG 95343 T06 E 001 A	1152-4-G
VG 95343 T06 E 002 A	1154-4-G
VG 95343 T06 E 003 A	1155-4-G
VG 95343 T06 E 004 A	1156-4-G
VG 95343 T06 E 005 A	1157-4-G
VG 95343 T06 E 006 A	1158-4-G
VG 95343 T06 E 007 A	1159-4-G
VG 95343 T06 E 008 A	1160-4-G
VG 95343 T06 F 001 A	1121-1-G
VG 95343 T06 F 002 A	1122-1-G
VG 95343 T06 F 003 A	1123-1-G
VG 95343 T06 F 004 A	1124-1-G
VG 95343 T06 F 005 A	1125-1-G
VG 95343 T06 F 006 A	1126-1-G
VG 95343 T06 F 007 A	1127-1-G
VG 95343 T06 F 008 A	1128-1-G
VG 95343 T06 F 009 A	1129-1-G
VG 95343 T06 F 010 A	1141-1-G
VG 95343 T06 F 011 A	1133-1-G

Description VG-Norm	Description HellermannTyton
VG 95343 T06 F 012 A	1134-1-G
VG 95343 T06 F 013 A	1135-1-G
VG 95343 T06 F 014 A	1136-1-G
VG 95343 T06 J 001 A	1111-1-G
VG 95343 T06 J 002 A	1112-1-G
VG 95343 T06 J 003 A	1113-1-G
VG 95343 T06 J 004 A	1114-1-G
VG 95343 T06 J 006 A	1116-1-G
VG 95343 T06 J 007 A	1117-1-G
VG 95343 T06 J 008 A	1118-1-G
VG 95343 T06 K 001 A	1505-1-G
VG 95343 T06 K 002 A	1506-1-G
VG 95343 T06 K 003 A	1507-1-G
VG 95343 T06 K 004 A	1501-1-G
VG 95343 T06 K 005 A	1502-2-G
VG 95343 T06 K 006 A	1502-2-G
VG 95343 T06 K 007 A	1506-2-G
VG 95343 T06 K 008 A	1507-2-G
VG 95343 T06 K 009 A	1501-2-G
VG 95343 T06 K 010 A	1502-1-G
VG 95343 T06 L 001 A	2101-1-G
VG 95343 T06 L 002 A	2102-1-G
VG 95343 T06 L 003 A	2103-1-G
VG 95343 T06 L 004 A	2104-1-G
VG 95343 T06 L 005 A	2105-1-G
VG 95343 T06 L 006 A	2101-2-G
VG 95343 T06 L 007 A	2102-2-G
VG 95343 T06 L 008 A	2103-2-G
VG 95343 T06 L 009 A	2105-2-G
VG 95343 T07 A 001 A	152-41-GP
VG 95343 T07 A 002 A	153-41-GP
VG 95343 T07 A 003 A	154-41-GP
VG 95343 T07 A 004 A	155-41-GP
VG 95343 T07 A 005 A	156-41-GP
VG 95343 T07 A 006 A	157-41-GP
VG 95343 T07 A 007 A	158-41-GP
VG 95343 T07 A 008 A	159-41-GP
VG 95343 T07 A 009 A	160-41-GP
VG 95343 T07 B 001 A	152-42-GP
VG 95343 T07 B 002 A	153-42-GP
VG 95343 T07 B 003 A	154-42-GP
VG 95343 T07 B 004 A	155-42-GP
VG 95343 T07 B 005 A	156-42-GP
VG 95343 T07 B 006 A	157-42-GP
VG 95343 T07 B 007 A	158-42-GP
VG 95343 T07 B 008 A	159-42-GP
VG 95343 T07 C 001 A	157-43-GP
VG 95343 T07 C 002 A	158-43-GP
VG 95343 T07 C 003 A	159-43-GP
VG 95343 T07 C 004 A	160-43-GP
VG 95343 T07 D 001 A	129-1-GP
VG 95343 T07 D 002 A	130-1-GP
VG 95343 T07 D 003 A	131-1-GP
VG 95343 T07 D 004 A	132-1-GP

Description VG-Norm	Description HellermannTyton
VG 95343 T07 D 005 A	133-1-GP
VG 95343 T07 D 006 A	134-1-GP
VG 95343 T07 D 007 A	135-1-GP
VG 95343 T07 D 008 A	136-1-GP
VG 95343 T07 D 009 A	138-1-GP
VG 95343 T07 D 010 A	187-1-GP
VG 95343 T07 E 001 A	1152-4-GP
VG 95343 T07 E 002 A	1154-4-GP
VG 95343 T07 E 003 A	1155-4-GP
VG 95343 T07 E 004 A	1156-4-GP
VG 95343 T07 E 005 A	1157-4-GP
VG 95343 T07 E 006 A	1158-4-GP
VG 95343 T07 E 007 A	1159-4-GP
VG 95343 T07 E 008 A	1160-4-GP
VG 95343 T07 F 002 A	1122-1-GP
VG 95343 T07 F 003 A	1123-1-GP
VG 95343 T07 F 004 A	1124-1-GP
VG 95343 T07 F 005 A	1125-1-GP
VG 95343 T07 F 006 A	1126-1-GP
VG 95343 T07 F 007 A	1127-1-GP
VG 95343 T07 F 008 A	1128-1-GP
VG 95343 T07 F 009 A	1129-1-GP
VG 95343 T07 F 010 A	1141-1-GP
VG 95343 T08 A 001 A	1203-1-G
VG 95343 T08 A 002 A	1209-1-G
VG 95343 T08 A 007 A	1201-1-G
VG 95343 T08 A 009 A	1206-1-G
VG 95343 T08 A 010 A	1202-1-G
VG 95343 T08 A 011 A	1207-1-G
VG 95343 T08 A 016 A	1204-1-G
VG 95343 T08 A 017 A	1216-1-G
VG 95343 T08 B 001 A	1301-1-G
VG 95343 T08 B 002 A	1303-1-G
VG 95343 T08 B 003 A	1311-1-G
VG 95343 T08 B 004 A	1302-1-G
VG 95343 T08 B 005 A	1304-1-G
VG 95343 T08 B 006 A	1305-1-G
VG 95343 T08 B 007 A	1312-1-G
VG 95343 T08 B 008 A	1316-1-G
VG 95343 T08 B 009 A	1313-1-G
VG 95343 T08 B 010 A	1306-1-G
VG 95343 T08 B 011 A	1307-1-G
VG 95343 T08 B 012 A	1308-1-G
VG 95343 T08 C 001 A	206-1-G
VG 95343 T08 C 002 A	203-1-G
VG 95343 T08 C 003 A	204-1-G
VG 95343 T08 C 004 A	211-1-G
VG 95343 T08 C 005 A	212-1-G
VG 95343 T08 D 001 A	306-1-G
VG 95343 T08 D 002 A	304-1-G
VG 95343 T08 D 003 A	310-1-G
VG 95343 T08 D 004 A	311-1-G
VG 95343 T08 E 002 A	411-1-G
VG 95343 T08 E 004 A	403-1-G
VG 95343 T08 E 005 A	413-1-G





Description VG-Norm	Description HellermannTyton
VG 95343 T09 A 001 A	1203-1-GP
VG 95343 T09 A 002 A	1209-1-GP
VG 95343 T09 A 003 A	1214-1-GP
VG 95343 T09 B 001 A	1301-1-GP
VG 95343 T09 B 002 A	1303-1-GP
VG 95343 T09 B 003 A	1311-1-GP
VG 95343 T09 C 001 A	206-1-GP
VG 95343 T09 C 002 A	203-1-GP
VG 95343 T09 C 003 A	204-1-GP
VG 95343 T15 A 001 A	V9500 PK
VG 95343 T15 A 002 B	V9500 B
VG 95343 T15 A	V9500 P
VG 95343 T15 DA	P9500
VG 95343 T15 MA	M9500
VG 95343 T18 A 001 A	152-41-GW24
VG 95343 T18 A 002 A	153-41-GW24
VG 95343 T18 A 003 A	154-41-GW24
VG 95343 T18 A 004 A	155-41-GW24
VG 95343 T18 A 005 A	156-41-GW24
VG 95343 T18 A 006 A	157-41-GW24
VG 95343 T18 A 007 A	158-41-GW24
VG 95343 T18 A 008 A	159-41-GW24
VG 95343 T18 A 009 A	160-41-GW24
VG 95343 T18 A 010 A	199-41-GW24
VG 95343 T18 E 001 A	1505-1-GW24
VG 95343 T18 E 002 A	1506-1-GW24
VG 95343 T18 E 003 A	1507-1-GW24
VG 95343 T18 E 004 A	1501-1-GW24
VG 95343 T18 E 005 A	1502-2-GW24
VG 95343 T18 E 006 A	1505-2-GW24
VG 95343 T18 E 007 A	1506-2-GW24
VG 95343 T18 E 008 A	1507-2-GW24
VG 95343 T18 E 009 A	1501-2-GW24
VG 95343 T18 E 010 A	1502-1-GW24
VG 95343 T18 B 001 A	152-42-GW24
VG 95343 T18 B 002 A	153-42-GW24
VG 95343 T18 B 003 A	154-42-GW24
VG 95343 T18 B 004 A	155-42-GW24
VG 95343 T18 B 005 A	156-42-GW24
VG 95343 T18 B 006 A	157-42-GW24
VG 95343 T18 B 007 A	158-42-GW24
VG 95343 T18 B 008 A	159-42-GW24
VG 95343 T18 B 009 A	160-42-GW24
VG 95343 T18 C 001 A	157-43-GW24
VG 95343 T18 C 002 A	158-43-GW24
VG 95343 T18 C 003 A	159-43-GW24
VG 95343 T18 C 004 A	160-43-GW24
VG 95343 T18 D 001 A	1152-4-GW24
VG 95343 T18 D 002 A	1154-4-GW24
VG 95343 T18 D 003 A	1155-4-GW24
VG 95343 T18 D 004 A	1156-4-GW24
VG 95343 T18 D 005 A	1157-4-GW24
VG 95343 T18 D 006 A	1158-4-GW24
VG 95343 T18 D 007 A	1159-4-GW24
VG 95343 T18 D 008 A	1160-4-GW24
VG 95343 T18 G 001 A	2101-1-GW24
VG 95343 T18 G 003 A	2102-1-GW24

Description VG-Norm	Description HellermannTyton
VG 95343 T18 G 005 A	2103-1-GW24
VG 95343 T18 G 006 A	2104-1-GW24
VG 95343 T18 G 007 A	2105-1-GW24
VG 95343 T18 G 008 A	2101-2-GW24
VG 95343 T18 G 010 A	2102-2-GW24
VG 95343 T18 G 012 A	2103-2-GW24
VG 95343 T18 G 014 A	2105-2-GW24
VG 95343 T18 H 001 A	1133-2-GW24
VG 95343 T18 H 002 A	1133-1-GW24
VG 95343 T19 A 001 A	1203-1-GW24
VG 95343 T19 A 002 A	1209-1-GW24
VG 95343 T19 A 003 A	1214-1-GW24
VG 95343 T19 A 004 A	1210-1-GW24
VG 95343 T19 A 006 A	1212-1-GW24
VG 95343 T19 A 007 A	1201-1-GW24
VG 95343 T19 A 008 A	1213-1-GW24
VG 95343 T19 A 009 A	1206-1-GW24
VG 95343 T19 A 010 A	1202-1-GW24
VG 95343 T19 A 011 A	1207-1-GW24
VG 95343 T19 A 012 A	1208-1-GW24
VG 95343 T19 A 016 A	1204-1-GW24
VG 95343 T19 A 017 A	1216-1-GW24
VG 95343 T19 A 018 A	1220-1-GW24
VG 95343 T19 E 002 A	411-1-GW24
VG 95343 T19 E 003 A	412-1-GW24
VG 95343 T19 E 004 A	403-1-GW24
VG 95343 T19 E 005 A	413-1-GW24
VG 95343 T19 E 009 A	414-1-GW24
VG 95343 T19 B 001 A	1301-1-GW24
VG 95343 T19 B 002 A	1303-1-GW24
VG 95343 T19 B 003 A	1311-1-GW24
VG 95343 T19 B 004 A	1302-1-GW24
VG 95343 T19 B 006 A	1305-1-GW24
VG 95343 T19 B 007 A	1312-1-GW24
VG 95343 T19 B 008 A	1316-1-GW24
VG 95343 T19 B 009 A	1313-1-GW24
VG 95343 T19 B 010 A	1306-1-GW24
VG 95343 T19 B 011 A	1307-1-GW24
VG 95343 T19 B 012 A	1308-1-GW24
VG 95343 T19 C 001 A	206-1-GW24
VG 95343 T19 C 002 A	203-1-GW24
VG 95343 T19 C 003 A	204-1-GW24
VG 95343 T19 C 004 A	211-1-GW24
VG 95343 T19 C 005 A	212-1-GW24
VG 95343 T19 D 001 A	306-1-GW24
VG 95343 T19 D 002 A	304-1-GW24
VG 95343 T19 D 003 A	310-1-GW24
VG 95343 T19 D 004 A	311-1-GW24
VG 95343 T19 D 005 A	312-1-GW24
VG 95343 T29 A 001 A	152-61-HW21
VG 95343 T29 A 002 A	153-61-HW21
VG 95343 T29 A 003 A	154-61-HW21
VG 95343 T29 A 004 A	155-61-HW21
VG 95343 T29 A 005 A	156-61-HW21
VG 95343 T29 A 006 A	157-61-HW21
VG 95343 T29 B 001 A	152-62-HW21
VG 95343 T29 B 002 A	153-62-HW21

Description VG-Norm	Description HellermannTyton
VG 95343 T29 B 003 A	154-62-HW21
VG 95343 T29 B 004 A	155-62-HW21
VG 95343 T29 B 005 A	156-62-HW21
VG 95343 T29 B 006 A	157-62-HW21
VG 95343 T29 B 007 A	158-62-HW21
VG 95343 T29 C 001 A	157-63-HW21
VG 95343 T29 C 002 A	158-63-HW21
VG 95343 T29 D 001 A	1152-6-HW21
VG 95343 T29 D 002 A	1154-6-HW21
VG 95343 T29 D 003 A	1155-6-HW21
VG 95343 T29 D 004 A	1156-6-HW21
VG 95343 T29 D 005 A	1157-6-HW21
VG 95343 T29 D 006 A	1158-6-HW21
VG 95343 T30 A 001 A	1203-1-HW21
VG 95343 T30 A 002 A	1209-1-HW21
VG 95343 T30 A 007 A	1201-1-HW21
VG 95343 T30 A 009 A	1206-1-HW21
VG 95343 T30 A 010 A	1202-1-HW21
VG 95343 T30 A 011 A	1207-1-HW21
VG 95343 T30 A 016 A	1204-1-HW21
VG 95343 T30 A 017 A	1216-1-HW21
VG 95343 T30 B 001 A	1301-1-HW21
VG 95343 T30 B 002 A	1303-1-HW21
VG 95343 T30 B 003 A	1311-1-HW21
VG 95343 T30 B 004 A	1302-1-HW21
VG 95343 T30 C 001 A	206-1-HW21
VG 95343 T30 C 002 A	203-1-HW21
VG 95343 T30 C 003 A	204-1-HW21
VG 95343 T30 C 004 A	211-1-HW21
VG 95343 T30 C 005 A	212-1-HW21
VG 95343 T30 D 001 A	306-1-HW21
VG 95343 T30 D 002 A	304-1-HW21
VG 95343 T30 D 003 A	310-1-HW21
VG 95343 T30 D 004 A	311-1-HW21



### VG Style/MIL Specification Style Cross Reference

Products listed below in VG style or MIL specification style can be substituted with each other, to achieve similar fit and function.

VG Parts	MIL Specification Parts
152-42	105-4
153-42	N/A
154-42	106-4
155-42	101-4
156-42	102-4
157-43	103-4
158-43	107-4
159-43	118-4
1152-4	1106-4
1154-4	1107-4
1155-4	1104-4
1156-4	1103-4
1157-4	1101-4
1158-4	1105-4
1159-4	1109-4
129-1	129-4*
130-1	130-4*
131-1	131-4*
132-1	132-4*
133-1	133-4*
134-1	134-4*
135-1	135-4*
136-1	136-4*
138-1	138-4*
187-1	187-4*
1122-1	1122-4*
1123-1	1123-4*
1124-1	1124-4*
1125-1	1125-4*
1126-1	1126-4*
1127-1	1127-4*
1128-1	1128-4*
1129-1	1129-4*
1141-1	1141-4*

\* Note: These have a longer overall length than VG parts



### HellermannTyton Shapes for use with circular MIL Specification Connectors MS 5015 AB

Connector Shell Size	Knurl Dia inch (mm)	Orientation		Cable Dia inch (mm)	
		Straight	90°	Min.	Max.
10 SL*	0.6" (15.7)	153-42	1152-4/1106-4*	0.2" (4.2)	0.3" (7.7)
14 S	0.8" (19.3)	154-42/106-4	1154-4/1107-4	0.3" (7.2)	0.4" (10.6)
16 S	0.9" (24.1)	155-42/101-4	1155-4/1104-4	0.3" (8.4)	0.5" (13.5)
16	0.9" (24.1)	155-42/101-4	1155-4/1104-4	0.3" (8.4)	0.5" (13.5)
18	0.9" (24.1)	155-42/101-4	1155-4/1104-4	0.3" (8.4)	0.6" (14.6)
20	1.2" (29.8)	156-42/102-4	1156-4/1103-4	0.4" (10.2)	0.7" (18.7)
22	1.2" (29.8)	156-42/102-4	1156-4/1103-4	0.4" (10.2)	0.8" (20.8)
24	1.5" (38.0)	157-43/103-4	1157-4/1101-4	0.5" (12.0)	1.0" (24.6)
28	1.5" (38.0)	157-43/103-4	1157-4/1101-4	0.5" (12.0)	1.1" (27.0)
32	1.9" (48.0)	158-43/107-4	1158-4/1105-4	0.8" (19.2)	1.3" (33.3)
36	1.9" (48.0)	158-43/107-4	1158-4/1105-4	0.8" (19.2)	1.5" (38.5)





\* Note: Shell 10 SL for 90° moulded part min cable diameter 6.6 mm (0.3")

### HellermannTyton Shapes for use with MIL-C-26482-I/II and 38999/Series I, II, III, IV

Connector Shell Size	Knurl Dia inch (mm)	Orientation		Cable Dia inch (mm)	
		Straight	90°	Min.	Max.
8/9	0.5" (13.0)	152-42/105-4	1152-4/1106-4	0.3" (7.2)	0.3" (7.0)
10/11	0.6" (15.0)	152-42/105-4	1152-4/1106-4	0.3" (7.2)	0.4" (10.0)
10/12	0.6"/0.7" (15.0/19.0)	153-42/NA	-	0.3" (7.2)	0.4"/0.5" (10.0/13.5)
12/13	0.7" (19.0)	154-42/106-4	1154-4/1107-4	0.3" (7.2)	0.5" (13.5)
14/15	0.8" (21.0)	155-42/101-4	1155-4/1104-4	0.3" (8.4)	0.6" (16.5)
16/17	0.9" (24.0)	155-42/101-4	1155-4/1104-4	0.3" (8.4)	0.8" (19.5)
18/19	1.0" (26.5)	156-42/102-4	1156-4/1103-4	0.4" (10.2)	0.9" (22.0)
20/21	1.2" (30.5)	156-42/102-4	1156-4/1103-4	0.4" (10.2)	1.0" (25.0)
22/23	1.3" (34.0)	157-43/103-4	1157-4/1101-4	0.5" (12.0)	1.1" (28.5)
24/25	1.4" (36.0)	157-43/103-4	1157-4/1101-4	0.5" (12.0)	1.2" (31.0)

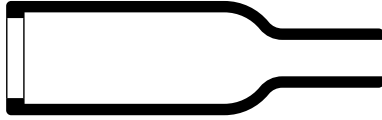

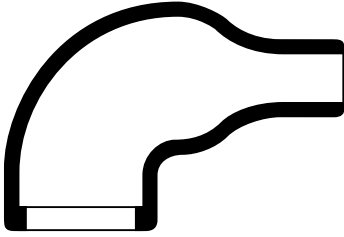
**MIL Specification Slash Sheet Cross Reference**

HellermannTyton	MS3109	Description	Style		
105-4-JL	-11AU	Bottle Shapes with rib "J" or "B7" material J = Red stripe B7 = White stripe Optional drainholes (D)			
105-4-B7L	-11BU				
106-4-JL	-12AU				
106-4-B7L	-12BU				
101-4-JL	-13AU				
101-4-B7L	-13BU				
102-4-JL	-14AU				
102-4-B7L	-14BU				
103-4-JL	-15AU				
103-4-B7L	-15BU				
107-4-JL	-16AU				
107-4-B7L	-16BU				
118-4-JL	-17AU				
118-4-B7L	-17BU				
129-4-JDL	-01AU			Low profile long outlet bottle shape with rib "J" or "B7" material J = Red stripe B7 = White stripe Supplied with drainholes (D)	
129-4-B7DL	-01BU				
130-4-JDL	-02AU				
130-4-B7DL	-02BU				
131-4-JDL	-03AU				
131-4-B7DL	-03BU				
132-4-JDL	-04AU				
132-4-B7DL	-04BU				
133-4-JDL	-05AU				
133-4-B7DL	-05BU				
134-4-JDL	-06AU				
134-4-B7DL	-06BU				
135-4-JDL	-07AU				
135-4-B7DL	-07BU				
136-4-JDL	-08AU				
136-4-B7DL	-08BU				
138-4-JDL	-09AU				
138-4-B7DL	-09BU				
187-4-JDL	-10AU				
187-4-B7DL	-10BU				
HellermannTyton	MS3117	Description	Style		
1106-4-JL	-11AU	Right angle shape with rib "J" or "B7" material J = Red stripe B7 = White stripe Optional drainholes (D)			
1106-4-B7L	-11BU				
1107-4-JL	-12AU				
1107-4-B7L	-12BU				
1104-4-JL	-13AU				
1104-4-B7L	-13BU				
1103-4-JL	-14AU				
1103-4-B7L	-14BU				
1101-4-JL	-15AU				
1101-4-B7L	-15BU				
1105-4-JL	-16AU				
1105-4-B7L	-16BU				
1109-4-JL	-17AU				
1109-4-B7L	-17BU				
1121-4-JDL	-01AU			Right angle shapes Low profile with rib "J" or "B7" material J = Red stripe B7 = White stripe Supplied with drainholes (D)	
1121-4-B7DL	-01BU				
1122-4-JDL	-02AU				
1122-4-B7DL	-02BU				
1123-4-JDL	-03AU				
1123-4-B7DL	-03BU				
1124-4-JDL	-04AU				
1124-4-B7DL	-04BU				
1125-4-JDL	-05AU				
1125-4-B7DL	-05BU				
1126-4-JDL	-06AU				
1126-4-B7DL	-06BU				
1127-4-JDL	-07AU				
1127-4-B7DL	-07BU				
1128-4-JDL	-08AU				
1128-4-B7DL	-08BU				
1129-4-JDL	-09AU				
1129-4-B7DL	-09BU				
1141-4-JDL	-10AU				
1141-4-B7DL	-10BU				

L denotes the MIL Specification Stripes.



## AS85049 Qualification

### Straight boots with Adhesive

Type A		Type B		Type D		Type G		Type H	
AS85049	HT part	AS85049	HT part	AS85049	HT part	AS85049	HT part	AS85049	HT part
/140-01AC	105-4-B7LW24	/140-01BC	105-4-JLW8	/140-01DC	*	/140-01GC	105-53-HLW21	/140-01HC	105-4-GLW24
/140-02AC	106-4-B7LW24	/140-02BC	106-4-JLW8	/140-02DC	*	/140-02GC	106-53-HLW21	/140-02HC	106-4-GLW24
/140-03AC	101-4-B7LW24	/140-03BC	101-4-JLW8	/140-03DC	*	/140-03GC	101-53-HLW21	/140-03HC	101-4-GLW24
/140-04AC	102-4-B7LW24	/140-04BC	102-4-JLW8	/140-04DC	*	/140-04GC	102-53-HLW21	/140-04HC	102-4-GLW24
/140-05AC	103-4-B7LW24	/140-05BC	103-4-JLW8	/140-05DC	*	/140-05GC	103-53-HLW21	/140-05HC	103-4-GLW24
/140-06AC	107-4-B7LW24	/140-06BC	107-4-JLW8	/140-06DC	*	/140-06GC	107-53-HLW21	/140-06HC	107-4-GLW24
/140-07AC	118-4-B7LW24	/140-07BC	118-4-JLW8	/140-07DC	*	/140-07GC	118-53-HLW21	/140-07HC	118-4-GLW24
/140-08AC	-	/140-08BC	-	/140-08DC	*	/140-08GC	-	/140-08HC	-
/140-09AC	129-4-B7LW24	/140-09BC	129-4-JLW8	/140-09DC	*	/140-09GC	129-50-HLW21	/140-09HC	129-4-GLW24
/140-10AC	130-4-B7LW24	/140-10BC	130-4-JLW8	/140-10DC	*	/140-10GC	130-50-HLW21	/140-10HC	130-4-GLW24
/140-11AC	131-4-B7LW24	/140-11BC	131-4-JLW8	/140-11DC	*	/140-11GC	131-51-HLW21	/140-11HC	131-4-GLW24
/140-12AC	132-4-B7LW24	/140-12BC	132-4-JLW8	/140-12DC	*	/140-12GC	132-51-HLW21	/140-12HC	132-4-GLW24
/140-13AC	133-4-B7LW24	/140-13BC	133-4-JLW8	/140-13DC	*	/140-13GC	133-51-HLW21	/140-13HC	133-4-GLW24
/140-14AC	134-4-B7LW24	/140-14BC	134-4-JLW8	/140-14DC	*	/140-14GC	134-51-HLW21	/140-14HC	134-4-GLW24
/140-15AC	135-4-B7LW24	/140-15BC	135-4-JLW8	/140-15DC	*	/140-15GC	135-51-HLW21	/140-15HC	135-4-GLW24
/140-16AC	136-4-B7LW24	/140-16BC	136-4-JLW8	/140-16DC	*	/140-16GC	136-51-HLW24	/140-16HC	136-4-GLW24
/140-17AC	138-4-B7LW24	/140-17BC	138-4-JLW8	/140-17DC	*	/140-17GC	138-51-HLW21	/140-17HC	138-4-GLW24
/140-18AC	187-4-B7LW24	/140-18BC	187-4-JLW8	/140-18DC	*	/140-18GC	187-51-HLW21	/140-18HC	187-4-GLW24
/140-19AC	176-4-B7LW24	/140-19BC	176-4-JLW8	/140-19DC	*	/140-19GC	176-50-HLW21	/140-19HC	176-4-GLW24
/140-20AC	177-1-B7LW24	/140-20BC	177-1-JLW8	/140-20DC	*	/140-20GC	177-5-HLW21	/140-20HC	177-1-GLW24
/140-21AC	178-1-B7LW24	/140-21BC	178-1-JLW8	/140-21DC	*	/140-21GC	178-5-HLW21	/140-21HC	178-1-GLW24
/140-22AC	179-1-B7LW24	/140-22BC	179-1-JLW8	/140-22DC	*	/140-22GC	179-5-HLW21	/140-22HC	179-1-GLW24
/140-23AC	1750-1-B7LW24	/140-23BC	1750-1-JLW8	-	*	/140-23GC	1750-1-HLW21	/140-23HC	1750-1-GLW24
/140-24AC	1751-1-B7LW24	/140-24BC	1751-1-JLW8	-	*	/140-24GC	1751-1-HLW21	/140-24HC	1751-1-GLW24
/140-25AC	1752-1-B7LW24	/140-25BC	1752-1-JLW8	-	*	/140-25GC	1752-1-HLW21	/140-25HC	1752-1-GLW24
/140-26AC	1753-1-B7LW24	/140-26BC	1753-1-JLW8	-	*	/140-26GC	1753-1-HLW21	/140-26HC	1753-1-GLW24
/140-27AC	1754-1-B7LW24	/140-27BC	1754-1-JLW8	-	*	/140-27GC	1754-1-HLW21	/140-27HC	1754-1-GLW24
/140-28AC	1755-1-B7LW24	/140-28BC	1755-1-JLW8	-	*	/140-28GC	1755-1-HLW21	/140-28HC	1755-1-GLW24

All items will have the option of Drain holes or Potting holes these will be signified by a D or P at the end of the AS Part number and after the material reference in the HellermannTyton part number. For ordering purpose AS will be substituted with H for example H85049/142-01AC.

\*Qualified with V9500 two part Epoxy adhesive please refer to Factory.



### Straight boots with No Adhesive

Type A		Type B		Type D		Type G		Type H	
AS85049	HT part	AS85049	HT part	AS85049	HT part	AS85049	HT part	AS85049	HT part
/140-01AU	105-4-B7L	/140-01BU	105-4-JL	/140-01DU	105-53-LL	/140-01GU	105-53-HL	/140-01HU	105-4-GL
/140-02AU	106-4-B7L	/140-02BU	106-4-JL	/140-02DU	106-53-LL	/140-02GU	106-53-HL	/140-02HU	106-4-GL
/140-03AU	101-4-B7L	/140-03BU	101-4-JL	/140-03DU	101-53-LL	/140-03GU	101-53-HL	/140-03HU	101-4-GL
/140-04AU	102-4-B7L	/140-04BU	102-4-JL	/140-04DU	102-53-LL	/140-04GU	102-53-HL	/140-04HU	102-4-GL
/140-05AU	103-4-B7L	/140-05BU	103-4-JL	/140-05DU	103-53-LL	/140-05GU	103-53-HL	/140-05HU	103-4-GL
/140-06AU	107-4-B7L	/140-06BU	107-4-JL	/140-06DU	107-53-LL	/140-06GU	107-53-HL	/140-06HU	107-4-GL
/140-07AU	118-4-B7L	/140-07BU	118-4-JL	/140-07DU	118-53-LL	/140-07GU	118-53-HL	/140-07HU	118-4-GL
/140-08AU	-	/140-08BU	-	/140-08DU	-	/140-08GU	-	/140-08HU	-
/140-09AU	129-4-B7L	/140-09BU	129-4-JL	/140-09DU	129-50-LL	/140-09GU	129-50-HL	/140-09HU	129-4-GL
/140-10AU	130-4-B7L	/140-10BU	130-4-JL	/140-10DU	130-50-LL	/140-10GU	130-50-HL	/140-10HU	130-4-GL
/140-11AU	131-4-B7L	/140-11BU	131-4-JL	/140-11DU	131-51-LL	/140-11GU	131-51-HL	/140-11HU	131-4-GL
/140-12AU	132-4-B7L	/140-12BU	132-4-JL	/140-12DU	132-51-LL	/140-12GU	132-51-HL	/140-12HU	132-4-GL
/140-13AU	133-4-B7L	/140-13BU	133-4-JL	/140-13DU	133-51-LL	/140-13GU	133-51-HL	/140-13HU	133-4-GL
/140-14AU	134-4-B7L	/140-14BU	134-4-JL	/140-14DU	134-51-LL	/140-14GU	134-51-HL	/140-14HU	134-4-GL
/140-15AU	135-4-B7L	/140-15BU	135-4-JL	/140-15DU	135-51-LL	/140-15GU	135-51-HL	/140-15HU	135-4-GL
/140-16AU	136-4-B7L	/140-16BU	136-4-JL	/140-16DU	136-51-LL	/140-16GU	136-51-HL	/140-16HU	136-4-GL
/140-17AU	138-4-B7L	/140-17BU	138-4-JL	/140-17DU	138-51-LL	/140-17GU	138-51-HL	/140-17HU	138-4-GL
/140-18AU	187-4-B7L	/140-18BU	187-4-JL	/140-18DU	187-51-LL	/140-18GU	187-51-HL	/140-18HU	187-4-GL
/140-19AU	176-4-B7L	/140-19BU	176-4-JL	/140-19DU	176-4-LL	/140-19GU	176-50-HL	/140-19HU	176-4-GL
/140-20AU	177-1-B7L	/140-20BU	177-1-JL	/140-20DU	177-1-LL	/140-20GU	177-5-HL	/140-20HU	177-1-GL
/140-21AU	178-1-B7L	/140-21BU	178-1-JL	/140-21DU	178-1-LL	/140-21GU	178-5-HL	/140-21HU	178-1-GL
/140-22AU	179-1-B7L	/140-22BU	179-1-JL	/140-22DU	179-1-LL	/140-22GU	179-5-HL	/140-22HU	179-1-GL
/140-23AU	1750-1-B7L	/140-23BU	1750-1-JL	-	-	/140-23GU	1750-1-HL	/140-23HU	1750-1-GL
/140-24AU	1751-1-B7L	/140-24BU	1751-1-JL	-	-	/140-24GU	1751-1-HL	/140-24HU	1751-1-GL
/140-25AU	1752-1-B7L	/140-25BU	1752-1-JL	-	-	/140-25GU	1752-1-HL	/140-25HU	1752-1-GL
/140-26AU	1753-1-B7L	/140-26BU	1753-1-JL	-	-	/140-26GU	1753-1-HL	/140-26HU	1753-1-GL
/140-27AU	1754-1-B7L	/140-27BU	1754-1-JL	-	-	/140-27GU	1754-1-HL	/140-27HU	1754-1-GL
/140-28AU	1755-1-B7L	/140-28BU	1755-1-JL	-	-	/140-28GU	1755-1-HL	/140-28HU	1755-1-GL

All items will have the option of Drain holes or Potting holes these will be signified by a D or P at the end of the AS Part number and after the material reference in the HellermannTyton part number. For ordering purpose AS will be substituted with H for example H85049/142-01AC.



## 90 Degree boots with Adhesive

Type A		Type B		Type D		Type G		Type H	
AS85049	HT part	AS85049	HT part	AS85049	HT part	AS85049	HT part	AS85049	HT part
/141-01AC	1106-4-B7LW24	/141-01BC	1106-4-JLW8	/141-01DC	*	/141-01GC	1106-50-HLW21	/141-01HC	1106-4-GLW24
/141-02AC	1107-4-B7LW24	/141-02BC	1107-4-JLW8	/141-02DC	*	/141-02GC	1107-50-HLW21	/141-02HC	1107-4-GLW24
/141-03AC	1104-4-B7LW24	/141-03BC	1104-4-JLW8	/141-03DC	*	/141-03GC	1104-50-HLW21	/141-03HC	1104-4-GLW24
/141-04AC	1103-4-B7LW24	/141-04BC	1103-4-JLW8	/141-04DC	*	/141-04GC	1103-50-HLW21	/141-04HC	1103-4-GLW24
/141-05AC	1101-4-B7LW24	/141-05BC	1101-4-JLW8	/141-05DC	*	/141-05GC	1101-52-HLW21	/141-05HC	1101-4-GLW24
/141-06AC	1105-4-B7LW24	/141-06BC	1105-4-JLW8	/141-06DC	*	/141-06GC	1105-50-HLW21	/141-06HC	1105-4-GLW24
/141-07AC	1109-4-B7LW24	/141-07BC	1109-4-JLW8	/141-07DC	*	/141-07GC	1109-50-HLW21	/141-07HC	1109-4-GLW24
/141-08AC	-	/141-08BC	-	/141-08DC	*	/141-08GC	-	/141-08HC	-
/141-09AC	1121-4-B7LW24	/141-09BC	1121-4-JLW8	/141-09DC	*	/141-09GC	1121-50-HLW21	/141-09HC	1121-4-GLW24
/141-10AC	1122-4-B7LW24	/141-10BC	1122-4-JLW8	/141-10DC	*	/141-10GC	1122-50-HLW21	/141-10HC	1122-4-GLW24
/141-11AC	1123-4-B7LW24	/141-11BC	1123-4-JLW8	/141-11DC	*	/141-11GC	1123-50-HLW21	/141-11HC	1123-4-GLW24
/141-12AC	1124-4-B7LW24	/141-12BC	1124-4-JLW8	/141-12DC	*	/141-12GC	1124-50-HLW21	/141-12HC	1124-4-GLW24
/141-13AC	1125-4-B7LW24	/141-13BC	1125-4-JLW8	/141-13DC	*	/141-13GC	1125-50-HLW21	/141-13HC	1125-4-GLW24
/141-14AC	1126-4-B7LW24	/141-14BC	1126-4-JLW8	/141-14DC	*	/141-14GC	1126-50-HLW21	/141-14HC	1126-4-GLW24
/141-15AC	1127-4-B7LW24	/141-15BC	1127-4-JLW8	/141-15DC	*	/141-15GC	1127-50-HLW21	/141-15HC	1127-4-GLW24
/141-16AC	1128-4-B7LW24	/141-16BC	1128-4-JLW8	/141-16DC	*	/141-16GC	1128-50-HLW21	/141-16HC	1128-4-GLW24
/141-17AC	1129-4-B7LW24	/141-17BC	1129-4-JLW8	/141-17DC	*	/141-17GC	1129-50-HLW21	/141-17HC	1129-4-GLW24
/141-18AC	1141-4-B7LW24	/141-18BC	1141-4-JLW8	/141-18DC	*	/141-18GC	1141-50-HLW21	/141-18HC	1141-4-GLW24
/141-19AC	1133-1-B7LW24	/141-19BC	1133-1-JLW8	/141-19DC	*	/141-19GC	1133-4-HLW21	/141-19HC	1133-1-GLW24
/141-20AC	1134-1-B7LW24	/141-20BC	1134-1-JLW8	/141-20DC	*	/141-20GC	1134-5-HLW21	/141-20HC	1134-1-GLW24
/141-21AC	1135-1-B7LW24	/141-21BC	1135-1-JLW8	/141-21DC	*	/141-21GC	1135-4-HLW21	/141-21HC	1135-1-GLW24
/141-22AC	1136-1-B7LW24	/141-22BC	1136-1-JLW8	/141-22DC	*	/141-22GC	1136-4-HLW21	/141-22HC	1136-1-GLW24

All items will have the option of Drain holes or Potting holes these will be signified by a D or P at the end of the AS Part number and after the material reference in the HellermannTyton part number. For ordering purpose AS will be substituted with H for example H85049/142-01AC.

\*Qualified with V9500 two part Epoxy adhesive please refer to Factory.



## 90 Degree boots with No Adhesive

Type A		Type B		Type D		Type G		Type H	
AS85049	HT part	AS85049	HT part	AS85049	HT part	AS85049	HT part	AS85049	HT part
/141-01AU	1106-4-B7L	/141-01BU	1106-4-JL	/141-01DU	1106-50-LL	/141-01GU	1106-50-HL	/141-01HU	1106-4-GL
/141-02AU	1107-4-B7L	/141-02BU	1107-4-JL	/141-02DU	1107-50-LL	/141-02GU	1107-50-HL	/141-02HU	1107-4-GL
/141-03AU	1104-4-B7L	/141-03BU	1104-4-JL	/141-03DU	1104-50-LL	/141-03GU	1104-50-HL	/141-03HU	1104-4-GL
/141-04AU	1103-4-B7L	/141-04BU	1103-4-JL	/141-04DU	1103-50-LL	/141-04GU	1103-50-HL	/141-04HU	1103-4-GL
/141-05AU	1101-4-B7L	/141-05BU	1101-4-JL	/141-05DU	1101-52-LL	/141-05GU	1101-52-HL	/141-05HU	1101-4-GL
/141-06AU	1105-4-B7L	/141-06BU	1105-4-JL	/141-06DU	1105-50-LL	/141-06GU	1105-50-HL	/141-06HU	1105-4-GL
/141-07AU	1109-4-B7L	/141-07BU	1109-4-JL	/141-07DU	1109-50-LL	/141-07GU	1109-50-HL	/141-07HU	1109-4-GL
/141-08AU	-	/141-08BU	-	/141-08DU	-	/141-08GU	-	/141-08HU	-
/141-09AU	1121-4-B7L	/141-09BU	1121-4-JL	/141-09DU	1121-50-LL	/141-09GU	1121-50-HL	/141-09HU	1121-4-GL
/141-10AU	1122-4-B7L	/141-10BU	1122-4-JL	/141-10DU	1122-50-LL	/141-10GU	1122-50-HL	/141-10HU	1122-4-GL
/141-11AU	1123-4-B7L	/141-11BU	1123-4-JL	/141-11DU	1123-50-LL	/141-11GU	1123-50-HL	/141-11HU	1123-4-GL
/141-12AU	1124-4-B7L	/141-12BU	1124-4-JL	/141-12DU	1124-50-LL	/141-12GU	1124-50-HL	/141-12HU	1124-4-GL
/141-13AU	1125-4-B7L	/141-13BU	1125-4-JL	/141-13DU	1125-50-LL	/141-13GU	1125-50-HL	/141-13HU	1125-4-GL
/141-14AU	1126-4-B7L	/141-14BU	1126-4-JL	/141-14DU	1126-50-LL	/141-14GU	1126-50-HL	/141-14HU	1126-4-GL
/141-15AU	1127-4-B7L	/141-15BU	1127-4-JL	/141-15DU	1127-50-LL	/141-15GU	1127-50-HL	/141-15HU	1127-4-GL
/141-16AU	1128-4-B7L	/141-16BU	1128-4-JL	/141-16DU	1128-50-LL	/141-16GU	1128-50-HL	/141-16HU	1128-4-GL
/141-17AU	1129-4-B7L	/141-17BU	1129-4-JL	/141-17DU	1129-50-LL	/141-17GU	1129-50-HL	/141-17HU	1129-4-GL
/141-18AU	1141-4-B7L	/141-18BU	1141-4-JL	/141-18DU	1141-50-LL	/141-18GU	1141-50-HL	/141-18HU	1141-4-GL
/141-19AU	1133-1-B7L	/141-19BU	1133-1-JL	/141-19DU	1133-4-LL	/141-19GU	1133-4-HL	/141-19HU	1133-1-GL
/141-20AU	1134-1-B7L	/141-20BU	1134-1-JL	/141-20DU	1134-5-LL	/141-20GU	1134-5-HL	/141-20HU	1134-1-GL
/141-21AU	1135-1-B7L	/141-21BU	1135-1-JL	/141-21DU	1135-4-LL	/141-21GU	1135-4-HL	/141-21HU	1135-1-GL
/141-22AU	1136-1-B7L	/141-22BU	1136-1-JL	/141-22DU	1136-4-LL	/141-22GU	1136-4-HL	/141-22HU	1136-1-GL

All items will have the option of Drain holes or Potting holes these will be signified by a D or P at the end of the AS Part number and after the material reference in the HellermannTyton part number. For ordering purpose AS will be substituted with H for example H85049/142-01AC.





### Transitions with Adhesive

Type A		Type B		Type D		Type G		Type H	
AS85049	HT part	AS85049	HT part	AS85049	HT part	AS85049	HT part	AS85049	HT part
/142-01AC	1206-1-B7LW24	/142-01BC	1206-1-JLW8	/142-01DC	*	/142-01GC	1206-1-HLW21	/142-01HC	1206-1-GLW24
/142-02AC	1202-1-B7LW24	/142-02BC	1202-1-JLW8	/142-02DC	*	/142-02GC	1202-1-HLW21	/142-02HC	1202-1-GLW24
/142-03AC	1207-1-B7LW24	/142-03BC	1207-1-JLW8	/142-03DC	*	/142-03GC	1207-1-HLW21	/142-03HC	1207-1-GLW24
/142-05AC	206-1-B7LW24	/142-05BC	206-1-JLW8	/142-05DC	*	/142-05GC	206-1-HLW21	/142-05HC	206-1-GLW24
/142-06AC	203-1-B7LW24	/142-06BC	203-1-JLW8	/142-06DC	*	/142-06GC	203-1-HLW21	/142-06HC	203-1-GLW24
/142-07AC	204-1-B7LW24	/142-07BC	204-1-JLW8	/142-07DC	*	/142-07GC	204-1-HLW21	/142-07HC	204-1-GLW24
/142-08AC	-	/142-08BC	-	/142-08DC	*	/142-08GC	-	/142-08HC	-
/142-09AC	306-1-B7LW24	/142-09BC	306-1-JLW8	/142-09DC	*	/142-09GC	306-1-HLW21	/142-09HC	306-1-GLW24
/142-10AC	304-1-B7LW24	/142-10BC	304-1-JLW8	/142-10DC	*	/142-10GC	304-1-HLW21	/142-10HC	304-1-GLW24
/142-11AC	310-1-B7LW24	/142-11BC	310-1-JLW8	/142-11DC	*	/142-11GC	310-1-HLW21	/142-11HC	310-1-GLW24
/142-12AC	311-1-B7LW24	/142-12BC	311-1-JLW8	/142-12DC	*	/142-12GC	311-1-HLW21	/142-12HC	311-1-GLW24
/142-13AC	-	/142-13BC	-	/142-13DC	*	/142-13GC	-	/142-13HC	-

\*Qualified with V9500 two part Epoxy adhesive please refer to Factory.

### Transitions with No Adhesive

Type A		Type B		Type D		Type G		Type H	
AS85049	HT part	AS85049	HT part	AS85049	HT part	AS85049	HT part	AS85049	HT part
/142-01AU	1206-1-B7L	/142-01B U	1206-1-JL	/142-01DU	1206-1-LL	/142-01G U	1206-1-HL	/142-01H U	1206-1-GL
/142-02AU	1202-1-B7L	/142-02B U	1202-1-JL	/142-02DU	1202-1-LL	/142-02G U	1202-1-HL	/142-02H U	1202-1-GL
/142-03AU	1207-1-B7L	/142-03B U	1207-1-JL	/142-03DU	1207-1-LL	/142-03G U	1207-1-HL	/142-03H U	1207-1-GL
/142-05AU	206-1-B7L	142-05B U	206-1-JL	/142-05DU	206-1-LL	/142-05G U	206-1-HL	142-05H U	206-1-GL
/142-06AU	203-1-B7L	142-06B U	203-1-JL	/142-06DU	203-1-LL	/142-06G U	203-1-HL	142-06H U	203-1-GL
/142-07AU	204-1-B7L	142-07B U	204-1-JL	/142-07DU	204-1-LL	/142-07G U	204-1-HL	142-07H U	204-1-GL
/142-08AU	-	142-08B U	-	/142-08DU	-	/142-08G U	-	142-08H U	-
/142-09AU	306-1-B7L	/142-09B U	306-1-JL	/142-09DU	306-1-LL	/142-09G U	306-1-HL	/142-09H U	306-1-GL
/142-10AU	304-1-B7L	/142-10B U	304-1-JL	/142-10DU	304-1-LL	/142-10G U	304-1-HL	/142-10H U	304-1-GL
/142-11AU	310-1-B7L	/142-11B U	310-1-JL	/142-11DU	310-1-LL	/142-11G U	310-1-HL	/142-11H U	310-1-GL
/142-12AU	311-1-B7L	/142-12B U	311-1-JL	/142-12DU	311-1-LL	/142-12G U	311-1-HL	/142-12H U	311-1-GL
/142-13AU	-	/142-13BU	-	/142-13DU	-	/142-13GU	-	/142-13HU	-

# Expertise worldwide

You will find your local contact here:

## Europe

 **HellermannTyton GmbH – Austria**  
Rennbahnweg 65  
1220 Vienna  
Tel.: +43 12 59 99 55-0  
Fax: +43 12 59 99 11  
Email: office@HellermannTyton.at  
www.HellermannTyton.at

 **HellermannTyton – Czech Republic**  
Email: officeCZ@HellermannTyton.at  
www.HellermannTyton.cz

 **HellermannTyton – Denmark**  
Industrivej 44A, 1.  
4000 Roskilde  
Tel.: +45 702 371 20  
Fax: +45 702 371 21  
Email: htdk@HellermannTyton.dk  
www.HellermannTyton.dk

 **HellermannTyton – Finland**  
Sähkötie 8  
01510 Vantaa  
Tel.: +358 9 8700 450  
Fax: +358 9 8700 4520  
Email: myynti@HellermannTyton.fi  
www.HellermannTyton.fi

 **HellermannTyton S.A.S. – France**  
2 rue des Hêtres - CS 80543  
78197 Trappes Cedex  
Tel.: +33 1 30 13 80 00  
Fax: +33 1 30 13 80 60  
Email: info@HellermannTyton.fr  
www.HellermannTyton.fr

 **HellermannTyton GmbH – Germany**  
Großer Moorweg 45  
25436 Tornesch  
Tel.: +49 4122 701-0  
Fax: +49 4122 701-400  
Email: info@HellermannTyton.de  
www.HellermannTyton.de

 **HellermannTyton KFT – Hungary**  
Kisfaludy u. 13  
1044 Budapest  
Tel.: +36 1 369 4151  
Fax: +36 1 369 4151  
Email: officeHU@HellermannTyton.hu  
www.HellermannTyton.hu

 **HellermannTyton Ltd – Ireland**  
Unit A5 Cherry Orchard  
Business Park  
Ballyfermot, Dublin 10  
Tel.: +353 1 626 8267  
Fax: +353 1 626 8022  
Email: sales@HellermannTyton.ie  
www.HellermannTyton.co.uk

 **HellermannTyton S.r.l. – Italy**  
Via Visco, 3/5  
35010 Limena (PD)  
Tel.: +39 049 767 870  
Fax: +39 049 767 985  
Email: info@HellermannTyton.it  
www.HellermannTyton.it

 **HellermannTyton B.V. – Belgium/Netherlands**  
Vanadiumweg 11-C  
3812 PX Amersfoort  
Tel.: +31 33 460 06 90  
Fax: +31 33 460 06 99  
Email (NL): info@HellermannTyton.nl  
Email (BE): info@HellermannTyton.be  
www.HellermannTyton.be

 **HellermannTyton AS – Norway**  
PO Box 240 Alnabru  
0614 Oslo  
Tel.: +47 23 17 47 00  
Fax: +47 22 97 09 70  
Email: firmapost@HellermannTyton.no  
www.HellermannTyton.no

 **HellermannTyton Sp. z o.o. – Poland**  
Kotunia 111  
62-400 Słupca  
Tel.: +48 63 2237111  
Fax: +48 63 2237110  
Email: info@HellermannTyton.pl  
www.HellermannTyton.pl

 **HellermannTyton – Romania**  
Email: officeRO@HellermannTyton.at  
www.HellermannTyton.at

 **OOO HellermannTyton – Russia**  
40/4, Pulkovskoe road  
BC Technopolis Pulkovo, office A 8081  
196158, St. Petersburg  
Tel.: +7 812 386 00 09  
Fax: +7 812 386 00 08  
Email: info@HellermannTyton.ru  
www.HellermannTyton.ru

 **HellermannTyton – Slovenia**  
Branch Office Ljubljana  
Podružnica Ljubljana, Leskovaška 6  
1000 Ljubljana  
Tel.: +386 1 433 70 56  
Fax: +386 1 433 63 21  
Email: officesl@HellermannTyton.at  
www.HellermannTyton.si

 **HellermannTyton España s.l. – Spain/Portugal**  
Avda. de la Industria 37 2 2  
28108 Alcobendas, Madrid  
Tel.: +34 91 661 2835  
Fax: +34 91 661 2368  
Email:  
HellermannTyton@HellermannTyton.es  
www.HellermannTyton.es

 **HellermannTyton AB – Sweden**  
Isafjordsgatan 5  
16440 Kista  
Tel.: +46 8 580 890 00  
Fax: +46 8 580 348 02  
Email: kundsupport@HellermannTyton.se  
www.HellermannTyton.se

 **HellermannTyton Engineering GmbH – Turkey**  
Saray Mah Dr. Adnan Büyükdüz Cad. No:4  
Akkom Office Park 2. Blok Kat: 10  
34768 Ümraniye-Istanbul  
Tel.: +90 216 687 03 40  
Fax: +90 216 250 32 32  
Email: info@HellermannTyton.com.tr  
www.HellermannTyton.com.tr

 **HellermannTyton Ltd – UK**  
William Prance Road  
Plymouth International Medical  
and Technology Park  
Plymouth, Devon PL6 5WR  
Tel.: +44 1752 701 261  
Fax: +44 1752 790 058  
Email: info@HellermannTyton.co.uk  
www.HellermannTyton.co.uk

 **HellermannTyton Ltd – UK**  
Sharston Green Business Park  
1 Robeson Way  
Altrincham Road, Wythenshawe  
Manchester M22 4TY  
Tel.: +44 161 947 2200  
Fax: +44 161 947 2220  
Email: sales@HellermannTyton.co.uk  
www.HellermannTyton.co.uk

 **HellermannTyton Ltd – UK**  
Cley Road, Kingswood Lakeside  
Cannock, Staffordshire  
WS11 8AA  
Tel.: +44 1543 728282  
Fax: +44 1543 728284  
Email: info@HellermannTyton.co.uk  
www.HellermannTyton.co.uk

 **HellermannTyton Data Ltd – UK**  
Cornwell Business Park  
43-45 Salthouse Road, Brackmills  
Northampton NN4 7EX  
Tel.: +44 1604 707 420  
Fax: +44 1604 705 454  
Email: sales@htdata.co.uk  
www.htdata.co.uk

## Middle East

 **HellermannTyton – UAE**  
Email: info@HellermannTyton.ae  
www.HellermannTyton.ae

## North America

 **HellermannTyton – Canada**  
Tel.: +1 905 726 1221  
Fax: +1 905 726 8538  
Email: sales@HellermannTyton.ca  
www.HellermannTyton.ca

 **HellermannTyton – Mexico**  
Tel.: +52 333 133 9880  
Fax: +52 333 133 9861  
Email: info@HellermannTyton.com.mx  
www.HellermannTyton.com

 **HellermannTyton – USA**  
Tel.: +1 414 355 1130  
Fax: +1 414 355 7341  
Email: corp@htamericas.com  
www.HellermannTyton.com

## South America

 **HellermannTyton – Argentina**  
Tel.: +54 11 4754 5400  
Fax: +54 11 4752 0374  
Email: ventas@HellermannTyton.com.ar  
www.HellermannTyton.com.ar

 **HellermannTyton – Brazil**  
Tel.: +55 11 4815 9000  
Fax: +55 11 4815 9030  
Email: vendas@HellermannTyton.com.br  
www.HellermannTyton.com.br

## Asia-Pacific

 **HellermannTyton – Australia**  
Tel.: +61 2 9525 2133  
Fax: +61 2 9526 2495  
Email: cservice@HellermannTyton.com.au  
www.HellermannTyton.com.au

 **HellermannTyton – China**  
Tel.: +86 510 8528 2536  
Fax: +86 510 8528 2731  
Email: cservice@HellermannTyton.com.cn  
www.HellermannTyton.com.cn

 **HellermannTyton – Hong Kong**  
Tel.: +852 2831 9090  
Fax: +852 2832 9381  
Email: cservice@HellermannTyton.com.hk  
www.HellermannTyton.com.sg

 **HellermannTyton – India**  
Tel.: +91 120 413 3384  
Email: cservice@HellermannTyton.co.in  
www.HellermannTyton.co.in

 **HellermannTyton – Japan**  
Tel.: +81 3 5790 3111  
Fax: +81 3 5790 3112  
Email: mkt@hellermanntyton.co.jp  
www.HellermannTyton.co.jp

 **HellermannTyton – Republic of Korea**  
Tel.: +82 32 833 8012  
Fax: +82 32 833 8013  
Email: cservice@HellermannTyton.co.kr  
www.HellermannTyton.co.kr

 **HellermannTyton – Philippines**  
Tel.: +82 32 752 6551  
Fax: +63 2 752 6553  
Email: cservice@HellermannTyton.com.ph  
www.HellermannTyton.com.ph

 **HellermannTyton – Singapore**  
Tel.: +65 6 586 1919  
Fax: +65 6 752 2527  
Email: cservice@HellermannTyton.sg  
www.HellermannTyton.com.sg

 **HellermannTyton – Thailand**  
Tel.: +662 237 6702 / 266 0624  
Fax: +662 266 8664  
Email: cservice@HellermannTyton.co.th  
www.HellermannTyton.com.sg

## Africa

 **HellermannTyton – South Africa**  
Tel.: +27 11 879 6600  
Fax: +27 11 879 6603  
Email: jhb.sales@HellermannTyton.co.za  
www.HellermannTyton.co.za

## Contact

If you have a particular problem that you would like us to help you with then please contact us.

With our vast experience and practically unlimited technical capabilities we are confident of being able to help you find a solution.

Remember, we are a service provider and not just a supplier.

### Give us a call!

Here are your contacts for enquiries and orders:

#### United Kingdom

HellermannTyton Ltd – UK

Tel.: +44 1752 701 261

Fax: +44 1752 790 058

Email: [heatshrinkshapes@HellermannTyton.co.uk](mailto:heatshrinkshapes@HellermannTyton.co.uk)

[www.HellermannTyton.co.uk](http://www.HellermannTyton.co.uk)

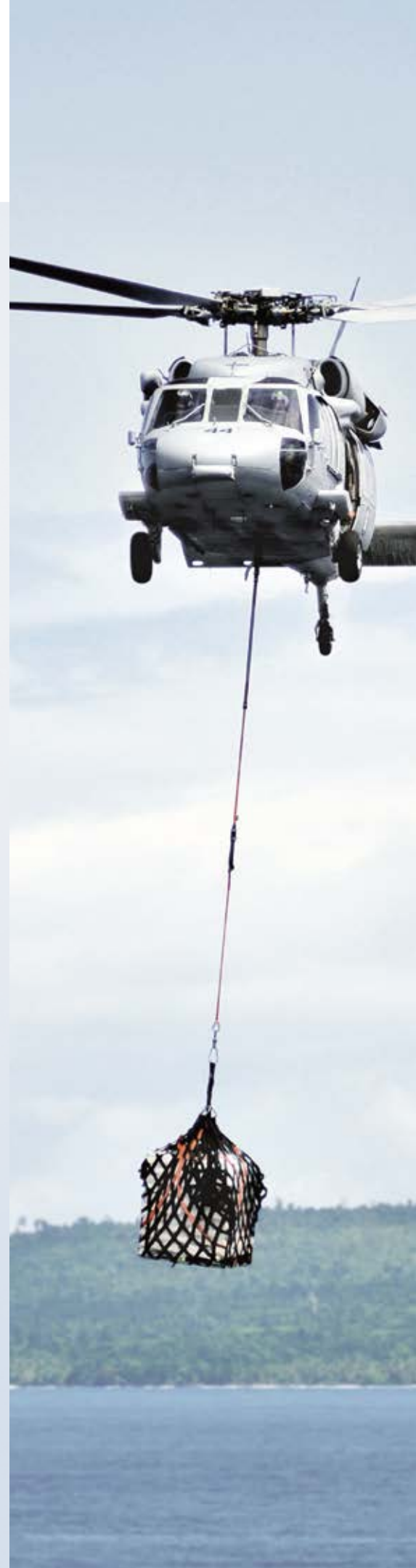



## HellermannTyton

### HellermannTyton Ltd – UK

William Prance Road  
Plymouth International Medical  
and Technology Park  
Plymouth, Devon PL6 5WR  
Tel.: +44 1752 701 261  
Fax: +44 1752 790 058  
Email: [heatshrinkshapes@HellermannTyton.co.uk](mailto:heatshrinkshapes@HellermannTyton.co.uk)  
[www.HellermannTyton.co.uk](http://www.HellermannTyton.co.uk)